



## JRC TECHNICAL REPORTS

# Handbook of Scenarios for Assessing Major Chemical Accident Risks

Gyenes, Zsuzsanna  
Wood, Maureen Heraty  
Struckl, Michael

2017



This publication is a Technical report by the Joint Research Centre (JRC), the European Commission's science and knowledge service. It aims to provide evidence-based scientific support to the European policymaking process. The scientific output expressed does not imply a policy position of the European Commission. Neither the European Commission nor any person acting on behalf of the Commission is responsible for the use that might be made of this publication.

#### Contact information

Name: Zsuzsanna Gyenes  
Address: 21027 Ispra, Italy Via E. Fermi 2749  
Email: [zsuzsanna.gyenes@ec.europa.eu](mailto:zsuzsanna.gyenes@ec.europa.eu)  
Tel.: +390332786732

#### JRC Science Hub

<https://ec.europa.eu/jrc>

JRC106029

EUR 28518 EN

PDF	ISBN 978-92-79-66670-4	ISSN 1831-9424	doi:10.2760/884152
Print	ISBN 978-92-79-66669-8	ISSN 1018-5593	doi:10.2760/642382

Luxembourg: Publications Office of the European Union, 2017

© European Union, 2017

The reuse of the document is authorised, provided the source is acknowledged and the original meaning or message of the texts are not distorted. The European Commission shall not be held liable for any consequences stemming from the reuse.

How to cite this report: Gyenes., Wood M-H., Struckl M., *Handbook of Scenarios for Assessing Major Chemical Accident Risks*, EUR 28518 EN, doi:10.2760/884152

All images © European Union 2017, except: cover page © mimadeo – Fotolia.com

# Contents

Contents .....	3
Acknowledgement .....	6
Abstract .....	7
Glossary.....	8
Executive Summary.....	15
1 Purpose and scope of the handbook.....	17
1.1 Background .....	17
1.2 Purpose of the Handbook .....	18
1.3 Accident Scenarios .....	19
1.4 What is a scenario? .....	19
1.5 Scenario trees provided in the Handbook.....	21
1.6 Scenario limitations - Possible physical effects for fires and explosions .....	23
2 Liquefied Petroleum Gas (LPG) Scenarios .....	26
2.1 LPG above ground pressurised storage tank.....	26
2.2 LPG pump/compressor .....	27
2.3 LPG Pipework.....	28
2.4 LPG loading/unloading arm/hose .....	29
2.5 LPG road tanker/rail tanker .....	30
3 Anhydrous ammonia accident scenarios .....	31
3.1 Anhydrous ammonia storage tank .....	31
3.2 Anhydrous ammonia pump/compressor.....	32
3.3 Anhydrous ammonia pipework .....	33
3.4 Anhydrous ammonia loading/unloading arm/hose.....	33
3.5 Anhydrous ammonia road tanker/rail tanker .....	34
4 Chlorine Accident Scenarios.....	35
4.1 Chlorine above ground pressurised storage tank .....	35
4.2 Chlorine pump/compressor.....	36
4.3 Chlorine pipework.....	36
4.4 Chlorine loading/unloading arm/hose .....	37
4.5 Chlorine road tanker/rail tanker .....	37
5 Liquefied Natural Gas (LNG) Accident Scenarios .....	38
5.1 Liquefied natural gas cryogenic atmospheric storage tank .....	38
5.2 LNG pump/compressor.....	39
5.3 LNG pipework .....	40

5.4 LNG loading/unloading arm/hose.....	41
5.5 LNG road tanker/rail tanker .....	42
6 Flammable Liquids Accident Scenarios .....	44
6.1 Flammable Liquid atmospheric storage tank .....	44
6.2 Flammable liquid pump .....	45
6.3 Flammable liquid pipework .....	46
6.4 Flammable Liquid loading/unloading arm/hose .....	47
6.5 Flammable liquid road tanker/rail tanker .....	48
7 Liquefied Oxygen Accident Scenarios .....	49
7.1 Liquefied oxygen cryogenic storage tank .....	49
7.2 Liquefied oxygen pump .....	50
7.3 Liquefied oxygen pipework .....	50
7.4 Liquefied oxygen loading/unloading arm/hose.....	51
8 Case Studies Using the Scenario Trees.....	52
8.1 The chlorine facility case study.....	54
8.2 The LPG depot case study .....	58
8.3 Results from the case study exercises.....	64
8.4 Conclusions .....	68
9 Annex I: Assessment of the Chlorine facility LUP Case by one Member State: United Kingdom (HSE) .....	69
Application of RHAD Event trees to Chlorine Case Study.....	69
Scenario development .....	69
Scenario Tree 1. Road Tanker (Event tree "Scenario for chlorine tank car/wagon")	69
Scenario Tree 2. Unloading Hose (Event tree "Scenario for chlorine loading/unloading") .....	70
Scenario Tree 3. Transfer Line (Event tree "Scenario for chlorine loading/unloading") .....	71
Scenario Tree 4. Storage Vessels (Event tree "Scenario for chlorine storage tank")	71
Scenario Tree 5. Feed Line (Event tree "Scenario for chlorine pipework") .....	72
Risk Assessment .....	73
Individual Risk .....	73
Societal Risk.....	73
Conclusions .....	74
Annex II: Assessment of the LPG Depot LUP case by one Member State: The Netherlands (RIVM).....	81
Part I: Describing the initiating event(s).....	81
Part II: Identifying all possible failures.....	82
Part III: Identifying all possible critical events (CE) .....	87

Part III: Selection of the critical event(s).....	90
Part IV: Describing the dangerous phenomena.....	95
Part V: Impact criteria .....	106
Part VI: Mitigation of consequences .....	108
9.1 Part VII: Final Land Use Decision.....	108
Annex III Identification of possible causes and safety barriers .....	110
10References .....	114

## **Acknowledgement**

This report has been edited by Zsuzsanna Gyenes, Maureen Heraty Wood, and Michael Struckl in close collaboration with the technical experts of an expert Task Force on Land Use Planning, specifically, Michalis Christou, Richard Gowland, Eelke Kooi, Fessel Benjelloun, Christophe Pécoult, Peter Frijns, Thomas Hackbusch, Karola Imbrechts, Clément Lenoble, Romualdo Marrazzo, Sophie Tost and Alessandro Tugnoli.

## **Abstract**

This report presents the collective work of the European Working Group on Land-Use Planning and discusses the activities towards more consistent land-use planning decisions through more understandable risk assessment approaches and data. The purpose of this book is to assist the EU Member States, especially those which do not have a consolidated system of approach, scenarios and criteria to assess the Land-Use Planning cases, in complying with the requirements of the Seveso Directive.

## Glossary

*Note: This glossary contains common terminology for describing aspects of chemical accident scenarios that may be useful to practitioners. Not all of these terms are present in the Handbook.*

**Atmospheric storage:** Storage tanks maintained at ambient temperature and pressure and containing a substance in a liquid state.

**Atmospheric transport equipment:** Transport equipment maintained at ambient temperature and pressure and containing a substance in a liquid state.

**BLEVE and possible fireball:** The term BLEVE is an acronym for Boiling Liquid Expanding Vapour Explosion). The BLEVE is one type of phenomena that may result from a catastrophic rupture. A BLEVE may occur when a vessel, containing a liquid highly superheated above its normal atmospheric boiling point, fails catastrophically. The risk of a BLEVE is typically associated with pressurized liquefied gas storage or pressurized liquids. The first consequence of a BLEVE is a blast effect due to vapour expansion when the vessel fails and to the explosive vapourization of the vessel liquid content. This effect is generally followed by missiles ejection. If the substance is flammable, the air-substance aerosol can ignite immediately. The flame front rapidly moves away from the ignition point, generating a fireball. Its temperature is extremely high and it causes an important thermal radiation.

**Boilover and resulting pool fire:** Typically associated with a tank fire, the boilover phenomenon is the sudden and violent eruption of burning liquid out of an atmospheric storage on fire. This is the consequence of vapourization of liquid water in the bottom of the tank. An atmospheric storage can lead to a boilover if the following requirements are met:

- Presence of water in the bottom of the tank
- The formation of a heat wave which meets the water layer under the hydrocarbons mass
- A sufficiently viscous hydrocarbon so that the water vapour cannot easily go through it from the tank bottom
- An average boiling temperature higher than the one of the water at the pressure of interface water/hydrocarbon. The condition is the following for the usual hydrocarbon storage  $T_{BUL\ HC} > 393K$  (120°C)
- A range of boiling temperatures large enough to generate a heat wave, that is to say, 60° beyond the boiling temperature of the water at the pressure of interface.

**Bow-tie method.** The bow-tie is a risk assessment method used to identify critical events, build accident scenarios, and study the effectiveness and influence of safety barriers.



### **Bow-tie Terminology:**

- **Critical event (CE) (in the bow-tie):** This term is commonly defined as the event causing a loss of containment (LOC). This definition is quite accurate for fluids, as they usually behave dangerously after release. For solids and more especially for mass solid storage, the term "loss of physical integrity" (LPI) is considered more appropriate, as the critical event in this case is the change of chemical and/or physical state of the substance. The critical event is the centre of the bow-tie
- **Dangerous phenomenon (DP) (right side):** This is an event following the tertiary critical event (for example, the pool fire after the ignition of a pool). Examples of dangerous phenomena are a vapour cloud explosion, a flash fire, etc.
- **Dangerous phenomenon with a "limited source term":** In this case, the consequences of the dangerous phenomenon are limited by a successful safety barrier at the source (for example, by limiting the size of the pool or the release duration)
- **Dangerous phenomenon with "limited effects":** Effects of the dangerous phenomenon are mitigated by a successful barrier in the event tree (for example, a water curtain acts to limit formation of gas clouds)
- **Dangerous phenomenon "fully developed":** Dangerous phenomenon whose effects are not limited by preventive or mitigating measures
- **Detailed direct causes (DDC) (left side):** The detailed direct cause is the event or collection of events that led to the direct cause
- **Direct causes (DC) (left side):** The immediate causes of the necessary and sufficient causes (NSCs). For a given NSC, the list of direct causes tends to be the most complete possible
- **Event tree:** Right part of the bow-tie, identifying the possible consequences of the critical event
- **Fault tree:** Left part of the bow-tie, identifying the possible causes of the critical event
- **Initiating event (IE):** the first causes upstream of each branch leading to the critical event in the fault tree (on the left end of the bowtie)
- **Major events - right side:** Significant effects caused by the dangerous phenomena on vulnerable objects (human beings, structure, environment, ...)
- **Necessary and sufficient causes (NSC)– left side:** A term referring to the immediate causes that can provoke a critical event. For a given critical event, the list of NSCs is supposed to be exhaustive, which means that at least one of the NSCs must be fulfilled so that the critical event can occur.
- **Secondary critical event (SCE) – right-side:** An event following the critical event (for example, the formation of a pool after a breach on a vessel)
- **Tertiary critical event (TCE) – right side:** An event following the secondary critical event (for example, the ignition of a pool after the formation of a pool).
- **Undesirable event (UE):** An undesirable event is any predictable deviation in a process or a system and is normally the first event on the left-side of the bow tie. The UE are, most of the time, generic events associated with organisational or human behaviour, that are ultimately considered as a cause of the critical event.

**Breach on the shell in liquid phase:** This critical event is a hole with a given diameter on the shell of equipment containing a substance in liquid phase (below the surface of the liquid), leading to a continuous release.

This hole can be due to a mechanical stress from external or internal causes causing a deterioration of mechanical properties of the structure.

**Breach on the shell in vapour phase:** This critical event is a hole with a given diameter on the shell of the equipment containing a substance in vapour phase (above the surface of the liquid if a liquid phase is present) leading to a continuous release. This hole can be due to a mechanical stress from external or internal causes causing a deterioration of mechanical properties of the structure. This event also includes a breach on equipment where a solid material is suspended in air or in gas.

**Catastrophic rupture:** A catastrophic rupture is the complete failure of the equipment leading to the complete and instantaneous release of the substance. A BLEVE is also a catastrophic rupture in particular operating conditions. Depending on the circumstances, the catastrophic rupture can lead to overpressure generation and missiles ejection.

**Collapse of the roof:** The collapse of the roof may be due to a decrease of the internal pressure in the vessel, leading to the collapse of the mobile roof under the effect of atmospheric pressure. The collapse of the roof is especially associated with atmospheric storage.

**Cryogenic storage (with cooling system):** This term refers to storage tanks maintained at atmospheric pressure or at a lower pressure and at a low temperature. The substance stored is a refrigerated liquefied gas.

**Dangerous (or hazardous) substance:** The Seveso Directive defines a hazardous substance as a dangerous substance' means a substance or mixture covered by Part 1 or listed in Part 2 of Annex I, including in the form of a raw material, product, by-product, residue or intermediate. The classification of hazardous substances in the Directive is derived from the EU CLP-Regulation (EC) No 1272/2008.

**Decomposition:** This critical event concerns only solid substances. It corresponds to a change of chemical state of the substance (loss of physical integrity) by action of an energy/heat source or by reaction with a chemical substance (incompatible reagent). The decomposition of the substance leads, as secondary and tertiary critical events, to an emission of toxic products or to a delayed explosion following formation of flammable gas. This critical event concerns only mass solid storage.

**Dust explosion:** It can happen if a high enough dust concentration exists in an oxidising atmosphere. The reaction of combustion happens at the interface gas/solid and the intensity of the explosion depends directly on the area of reaction, that is to say the particle size. They can principally cause overpressure effects and missiles projection.

**Effectiveness of a safety barrier:** The effectiveness is the ability for a technical safety barrier to perform a safety function for the duration of an undesired event, in a non-degraded mode, for a pre-specified set of circumstances. The effectiveness is either a percentage or a probability of that the defined safety function will perform as intended. If the effectiveness is expressed as a percentage, it may vary during the operating time of the safety barrier. For example, a valve that does not completely close on demand would not have an effectiveness of 100%.

**Environmental damage:** This dangerous phenomenon results from dispersion of a substance identified as dangerous to the environment in sufficient consequences to effect the natural environment. It can also result from an emission of toxic vapours from the combustion of certain substances.

**Explosion:** This critical event is only associated with solid substances classified as explosives. It corresponds to a change of physical state of the substance (LPI) by action of a energy/heat source or by action of a chemical source (incompatible reagent). This change of state implies combustion of a solid with overpressure generation (or an explosion) due to a violent and spontaneous reaction. In case of a substance stored in a closed vessel, an explosion (or an explosive decomposition of solid) is considered as an internal cause of overpressure leading to a loss of containment (for example, catastrophic rupture or breach on the shell).

**Fire:** The fire is a process of combustion characterized by heat or smoke or flame or any combination of these three.

**Jet fire:** The handling of pressurised flammable liquid or gas can lead to a jet fire in case of a leak on a pipe or on a vessel. The fluid ignition lead to form a jet flame characterised by a high radiant energy (largely higher than pool fire radiation) and by a noticeable kinetic energy.

**Leak from gas pipe:** This critical event is a hole with a diameter corresponding to a given percentage of the nominal diameter of the pipe. It can also be a leak from a functional opening on the pipe: flanged joints, pump seals, valves, plugs, seals, ... This leak occurs on a pipe carrying a gaseous substance. This critical event includes also a leak on equipment where a solid material is in suspension in air or in gas.

**Leak from liquid pipe:** This critical event is a hole with a diameter corresponding to a given percentage of the nominal diameter of the pipe. It can also be a leak from a functional opening on the pipe: flanged joints, pump seals, valves, plugs, seals, ... This leak occurs on a pipe carrying a liquid substance.

**Level of confidence of a safety barrier:** The probability of failure on demand to perform properly a required safety function according to a given effectiveness and response time under all the stated conditions within a stated period of time. This notion is similar to the notion of SIL (Safety Integrity Level) defined in IEC 61511 for Safety Instrumented Systems but applies here to all types of safety barriers. The "design" level of confidence is assessed with the help of instruction given in Appendix 8 of the IEC standard. The barrier is assumed to be maintained so that it is as efficient as when it was installed, to have the same response time and the same level of confidence or probability of failure on demand.

The "operational" level of confidence includes the influence of the safety management system. The value could be lower than the "design" one if some problems are identified during the audit of the safety management system.

**(Un)loading unit:** unit used for inlet and outlet of substances in the establishment, involving transport equipment.

**Mass solid storage: storage of solid substances in the form of powder or pellets:**

These substances may be stored in bulk or in silos (solid products storage in form of "small" bags are not taken into account here).

**Material set in motion (entrainment by air):** This critical event is reserved for a potentially mobile solid, to a fragmented solid (powder, dust, ...) exposed to the ambience (e.g., fragmented solid in an open storage or in conveyor belts) and occurs due to the presence of an air vector (e.g., too high ventilation, ...)

**Material set in motion (entrainment by a liquid):** This critical event is reserved for a potentially mobile solid exposed to the ambience (e.g., fragmented solid in an open storage or in conveyor belts) and occurs due to the presence of a liquid vector (e.g. flooding, liquid escaping from other equipment, ...)

**MIMAH:** Methodology for the Identification of Major Accident Hazards

**MIRAS:** Methodology for the Identification of Reference Accident Scenarios

**Missiles ejection:** Various equipment items can be concerned by an explosion or by a pressure increase causing their burst with missile(s) ejection:

- The BLEVE of a pressure vessel can generate missiles.
- Explosive phenomena can occur in process equipment and cause the projection of fragments, for instance, a run-away in a reactor.
- Atmospheric or cryogenic storage tanks can also produce missiles (tank explosion). It can mainly occur in the case of an accumulation of flammable vapours under the tank roof.
- Mechanical bursting of pressure storage due, for example, to a increase of the pressure in the tank.

**Overpressure generation:** A rapidly propagating pressure or shock-wave in atmosphere with high pressure, high density and high velocity.

**Padded storage:** Storage tanks working at ambient temperature and at a pressure above 1 bar (the pressure is exerted by a pad of inert gas) and containing a substance in a liquid state.

**Pipe network (pipe):** Piping linking different units of the plant is considered as "pipe network (pipes)" (for example, a pipe linking an unloading unit and a storage unit, or linking a storage unit and a process unit), as well as pipes feeding the flare. Piping staying inside a unit (for example, inside a storage farm, or between two process equipment of the same process unit) is not considered as "pipe". They are integral part of the equipment to which they are linked.

**Poolfire:** The combustion of material evaporating from a layer of liquid (a pool). The occurrence of the layer of liquid results from the failure of equipment containing a flammable liquid.

**Pressure storage:** Storage tanks working at ambient temperature and at a pressure above 1 bar (pressure exerted by the substance, eventually with an inert gas). The substance stored can be a liquefied gas under pressure (two phase equilibrium) or a gas under pressure (one phase).

**Pressure transport equipment:** Transport equipment working at ambient temperature and at a pressure above 1 bar (pressure exerted by the substance, eventually with an inert gas). The substance stored can be a liquefied gas under pressure (two phase equilibrium) or a gas under pressure (one phase).

**Process unit:** unit used for the processing of substances or for the production of energy used in the establishment. In the process unit, equipment generally belongs to one or more general categories, as indicated below. For each category of equipment, examples are given but they do not constitute an exhaustive list.

- Intermediate storage equipment integrated into the process, e.g., mass solid storage, pressure storage, padded storage, atmospheric storage, cryogenic storage
- Equipment involving chemical reactions, e.g., reactor
- Equipment devoted to the physical or chemical separation of substances, e.g., distillation column, absorption column, centrifuge, separators, dryers, sieves, classifiers
- Equipment designed for energy production and supply, e.g., furnaces, boilers, direct-fired heat exchangers
- Packaging equipment, equipment dedicated to the packaging of material. Packages are not included here, but only the packaging system
- Other facilities, e.g., pumps, heat exchangers, compressors, gas expansion facility, piping internal to the process unit, mixers; blenders, etc. ...

**Rain-out:** Release of small liquid drops from the fraction of the flashing liquid that remains initially suspended in the atmosphere.

**Relevant hazardous equipment:** Equipment containing a quantity of hazardous substance higher or equal to a threshold–quantity.

**Response time:** Time elapsed from the moment a demand is imposed on the safety barrier and its complete achievement. The response time is measure of the effectiveness of the safety function performed by the safety barrier.

**Safety barrier:** A safety barrier is a physical, engineered system or human action (e.g., specific procedures, administrative controls) planned in advance to prevent, control, or mitigate undesired events or accidents. They can avert the progression of a potential accident scenario or alter the outcome so that effects are less severe. The safety barrier directly serves the safety function.

**Safety function:** A safety function is the specific action performed by the safety barrier (e.g., close the valve, stop the process, etc.).

**Start of fire (LPI):** This critical event corresponds to the specific reaction between an oxidizing substance and a flammable or combustible substance, or to the autonomous decomposition of organic peroxide leading to a fire. This critical event concerns only substances that may cause fire (organic peroxides) or that may cause fire when in contact with combustible materials. This event can also be associated with pyrotechnic substances.

**Storage unit:** Unit used for the storage of raw materials, intermediate goods, manufactured products, or waste products.

**Storage of solids in small packages:** Low capacity storage of solids in bags and in storage tanks with individual volume smaller than 1 m<sup>3</sup>.

**Storage of fluid in small packages:** Low capacity storage of fluids in carboys or drums and all storage tanks with individual volume smaller than 1 m<sup>3</sup>.

**Tank fire:** The tank fire is generally the consequence of the ignition of the gaseous phase in a vessel containing a flammable liquid.

**Toxic cloud:** Mixing and spreading of toxic gases in air, which causes clouds to grow. The mixing is the result of turbulent energy exchange that is a function of a particular wind and atmospheric temperature profile.

**Unit:** One or more grouped operations in an industrial establishment that can be defined and separated from others, e.g., storage units, (Un)loading Units, pipes networks, process units

**Vapour cloud explosion and flash fire:** When a leakage occurs on an equipment item, a gaseous release can occur, either directly, or following the gradual vaporization of a pool on the ground close to the leakage. This event leads to the formation of a cloud that drifts and disperses with the wind. If the substance is flammable, there is an intermediate zone in which the vapour concentrations in the air are between the flammability limits of the substance. A sufficiently energetic ignition source, on the trajectory of the flammable zone of the cloud, may ignite this cloud. According to the front flame speed, the accident will lead to a flash fire or a VCE (vapour cloud explosion). The latter event causes an overpressure – underpressure wave. A devastating effect is associated with the peak overpressure as well as with the wave shape.

**Vessel collapse:** A vessel collapse is the complete failure of the equipment, due to a decrease of the internal pressure in the vessel leading to the collapse of the vessel under the effect of atmospheric pressure. This event leads to the complete and instantaneous release of the substance in the vessel. The vessel collapse does not lead to overpressure generation nor missiles ejection.

## Executive Summary

It is evident from past accidents in Europe and elsewhere that the consequences of industrial accidents can be severely aggravated because of the proximity of hazardous establishments to residential areas, transport hubs, commercial centres, public spaces and services. The devastating fireworks accident in the Dutch town of Enschede killed 22 people, injured over 900 and destroyed a significant part of the built environment of this town. A little over a year later, the explosion of an ammonium nitrate storage facility in Toulouse, France caused over 30 deaths, 10,000 injuries as well as significant property damage and psychological trauma to the surrounding population due to its close proximity to dense urban areas.

With the aim of reducing the impacts from major chemical accidents, a legal requirement was introduced into the Seveso Directive in 1996 to encourage the establishment of appropriate safety distances between these areas and Seveso sites. The Directive does not provide detailed suggestions on how EU Member States should implement this requirement into their land-use planning policies. This approach reflects a conscientious application of the EU subsidiarity principle such that the Directive recognises that land-use planning is guided by historic and social values unique to each country.

As a result, methods and criteria for applied to fulfill Seveso land-use planning obligations in the different Member States are quite diverse, even though they all aim to achieve the same objective, that is, to evaluate the potential consequences of possible major accidents for use in making land-use planning decisions. In particular, each country has established its own process for evaluating the risk associated with specific chemical accident hazards. Each applies a variation of the standard risk assessment approaches to incorporate the estimated risk into land-use planning decisions (see Annex 1). Part of the process also includes, for some or all sites, depending on the country, an estimate of the risk associated with the hazardous site based on the analysis of consequences associated with a specific accident scenario or scenarios. Scenarios are selected based on information in the safety reports and site notifications. Calculation of risk estimates may be based on the data provided by the site or may be the regulator's own standardized datasets.

Given the numerous possible inputs and the diversity of risk assessment and land-use protocols, the outcome of the land-use planning process for the same type of site can differ considerably from one country to the next. Much of this variation is difficult to avoid. It has long been acknowledged that risk methods and land-use planning processes are embedded in local culture and pre-existing legal systems. However, technical aspects associated with the consequence analysis, in particular, selection of scenarios and scenario attributes, are not subject to this constraint and yet they are distinctly different from country to country. Up until now, there has been no common accepted practice among Member States for determining which scenarios should be taken into account in the land use planning process.

To address the issue, the Major Accident Hazards Bureau (MAHB) of the European Commission's Joint Research Centre (JRC), together with the Land-Use Planning Task Force, a group of industry and competent authority experts from European Union (EU) Member States, produced this Handbook of Scenarios for Assessing Major Chemical Accident Risks. The availability of common reference scenarios allows the possibility for all authorities to consider the full range of possible outcomes when assessing risks associated with a major hazard site. Although it does not in any way ensure that authorities will arrive at similar risk figures or planning decisions, it gives a common framework in which the rules of science and logic can be applied. The use of common reference scenarios can, in particular, give citizens more confidence that authorities are ensuring that all necessary measures are being taken to reduce the impacts from serious chemical accidents.

The Handbook gives recommendations on possible major accident scenarios in the form of scenario trees. It is expected that the scenario recommendations will be useful to EU Member States and third countries who do not have a fixed LUP approach in place. A scenario tree is a taxonomy that shows the most relevant ways that an accident involving a certain dangerous substance may occur, using the structure of a bow-tie diagram. The scenario trees presented in the Handbook describe the dangerous substance and piece of equipment that may be involved in the accident, the critical event and the dangerous phenomena following the critical event. In the Handbook, five dangerous substances and four pieces of equipment have been identified and developed as scenario trees. These trees contain the main qualitative information with regards to potential sequences of events following a release. They can be used for land-use planning decisions or for emergency planning. The Handbook also offers a list of possible causes and safety barriers for the scenario trees studied. Therefore, quantitative information and data can be added to the qualitative description of the scenarios in order to make them quantifiable.

The Handbook proposes basic sets of scenarios and data input options to support consistent and transparent decision-making in land-use planning decisions associated with implementation of the Seveso Directive (2012/18/EU). This information is primarily aimed to assist EU Member States and other Seveso implementing countries in land-use planning, especially those that do not have consolidated a systematic approach of scenarios and criteria for assessing land-use planning cases in compliance with the requirements of the Seveso Directive. In addition, it is also possible to use the scenarios for emergency planning, provided outcomes are interpreted to conform with criteria appropriate for emergency response applications.

The Handbook begins with a general chapter that explains its overall purpose and scope, and, in particular, the importance of the accident scenario in risk assessment for chemical accident prevention and preparedness. The subsequent seven chapters provide common reference scenarios for each of 6 types of dangerous substances commonly used throughout the European Union (EU). The final chapter describes a benchmarking exercise in which eight different teams of experts from regional and national authorities of the EU conduct risk assessments for land-use planning on two fictitious sites using the common reference scenarios in this handbook.



# 1 Purpose and scope of the handbook

## 1.1 Background

An EU Technical Working Group on Land-Use Planning was first established in 1996 to study existing land-use planning practices in Member States. Most of the Member States did not have a consolidated land-use planning approach established at that time, while those who did were employing different approaches with varying results. This discrepancy in approaches, and corresponding diversity in decision outcomes of the land-use planning process in the different countries, was documented reported in the European Commission Guidance on Land Use Planning produced by this group (Christou and Porter, 1999) and in the literature (Christou et.al., 1999; Cozzani et.al., 2006). In the aftermath of the accident in Toulouse, a seminar on land-use planning was organised by the French Authorities and the JRC in Lille, France. The lack of transparency and consistency in land-use planning processes under Seveso across the EU emerged as a common concern. It was recognised that significant differences in Member State approaches could, and probably did, lead to vastly different decisions in EU Member States on what constituted an appropriate safety distance between similar uses vis-à-vis a given risk profile. These differences were largely due to the diversity of inputs and approaches associated with the consequence analysis, including the scenarios, criteria, models, frequency and other assumptions, as well as the acceptance criteria and decision-making frameworks of the different Member States. In this situation, national government was particularly vulnerable to accusations of underregulation or overregulation (depending on the situation) in comparison to other Member States.

In theory, the logical solution would have been to develop a harmonized approach and common risk acceptance criteria for universal application across the EU, but historical norms and culture differences (especially in risk tolerance) between Member States rendered such an outcome unlikely. Instead, the seminar findings included a recommendation that, in the place of harmonized approaches, the definition of common principles and common scenarios, and the availability – as much as possible - of common data sets for use in frequency and modelling the consequence analysis within risk assessments could establish a level of comparability between Member State land-use planning processes under Seveso. Seminar participants considered that use of a common knowledgebase would lead to more consistent decisions in similar risk situations across the EU, and thus help enormously with the transparency and the 'dependability' (i.e., the ease with which certain decisions can be defended in a public debate) of resulting decisions. In addition, the participants recommended the revival of the Technical Working Group.

As a result, the 2003 amendment of the Seveso Directive (Council Directive 2003/105/EC) brought a mandate for the European Commission to develop guidelines "in close cooperation with the Member States defining a technical database including risk data and risk scenarios". In the context of the respective work, the re-activated group, renamed the European Working Group on Land-Use Planning (EWGLUP), developed a new guideline document (Christou et.al., 2006) and a report summarising of "roadmaps" of good practice (Basta, et.al., 2008).

One of the mandates of the EWGLUP Group was the development of a commonly agreed database of risk and hazard assessment data (RHAD). This development was based on the risk assessment practice of sources such as the Dutch "Purple Book", the ARAMIS project (Delvosalle et.al, 2005), etc. Based on this requirement, RHAD was intended to facilitate systematic selection of scenarios for land-use planning purposes (Christou et.al, 2006).

The European Commission disbanded the EWGLUP in 2011 concluding that its work was largely completed with the exception of the technical database. The development of a common database for land-use planning proved infeasible because of the variations of existing examples and practices in the Member States. Taking over from the EWGLUP, the Task Force on Land-Use Planning conceived the idea of defining common reference scenarios as an alternative. This Handbook represents the fruits of their collaboration on this topic.

## **1.2 Purpose of the Handbook**

This Handbook is primarily aimed to assist the EU Member States and other Seveso implementing countries in land-use planning, especially those that have not consolidated a systematic approach to selecting scenarios and criteria for assessing land-use planning cases in the context of Seveso Directive implementation. It is also possible to use the scenarios for emergency planning, provided outcomes are interpreted to conform with criteria appropriate for emergency response applications. It is also acknowledged that even when the same scenario is selected for similar sites, results may differ significantly due to application of different data, models and assumptions.

The contents of the Handbook are not recommendations, but rather they represent recognized good practice within the EU Member States. As such, its use is not obligatory. It is expected that authorities engaged in land-use planning will use it as a handbook, or as a collection of reference scenarios that are typically associated with land-use planning. Its content does not exclude the possibility of additional scenarios, that may be required for a specific case, and it is understood that particular installations may require different scenarios all together. Nonetheless, the information herein may be considered a good starting point for a land-use planning risk assessment and definition of appropriate safety distances, with direct application to many sites, or alternatively, providing ideas for developing new and different scenarios for other sites and circumstances.

As of 4th July 2012 the Seveso III Directive was published and will be in force from 1st June 2015. The former Article 12 of the Seveso II Directive is now Article 13 of Directive 2012/18/EC (Seveso III). As this report is mainly focused on the technical matters of the requirements of land-use planning in the context of the Seveso Directive the editors abstain from a detailed analysis or interpretation of text modifications. It only shall be noted that the mandate for the elaboration of a common database for land-use planning tasks was deleted, whereas all the relevant requirements of the former Article 12 remain. It is an undisputed target of the implementation of EU legislation to seek to achieve coherent and common enforcement as far as possible; the Handbook remains a useful tool for meeting this target.

### 1.3 Accident Scenarios

Every land-use and emergency planning approach starts with evaluation of the consequences associated with a credible major accident scenario. Some sites may have only a few credible accident scenarios, for example, warehouses and fuel storage depots, but as more processes and hazard substances are present on the site, the number of potential accident scenarios that can be generated will also increase. It is particularly important to select accident scenario or scenarios that are most representative of the actual risk present on the site to ensure effective implementation of land-use planning policy.

### 1.4 What is a scenario?

A scenario describes the conditions that might lead to a major accident and the potential consequences, which in most cases is the loss of containment (LOC) also known as the critical event (CE), of a hazardous substance, or the change of state of a solid substance, combined with particular conditions that eventually lead to a fire, explosion, and/or toxic release. In the EU Seveso Land-Use Planning Guidelines a “scenario” to be used for LUP risk analysis is defined as:

Scenario = “Top Event” (usually/mostly Loss of Containment) & Dangerous Phenomenon (fire, explosion, toxic cloud)

This definition means that two elements generally analyzed separately are merged in order to simplify the assessment. It is represented below using the so-called bow-tie diagram:

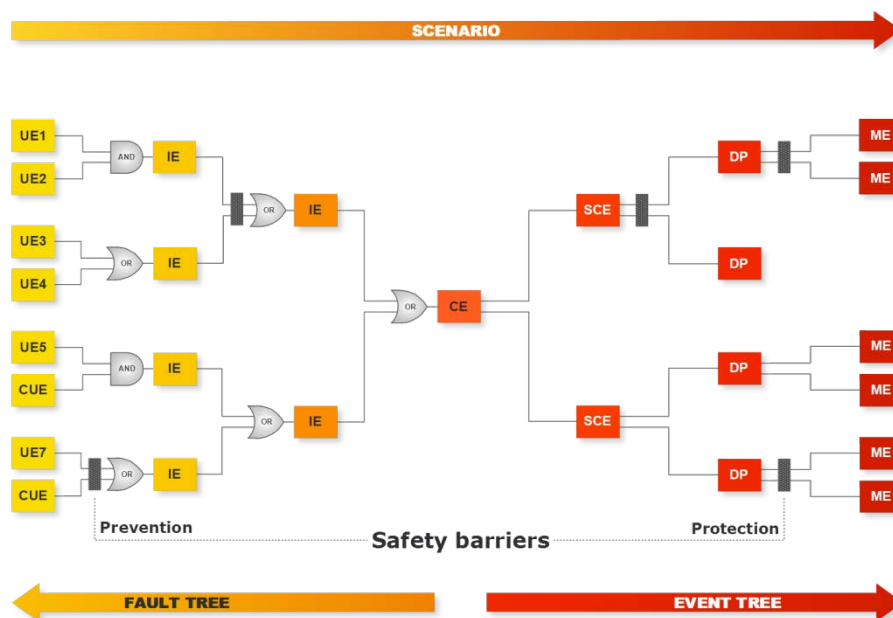

Figure 1 A scenario as depicted in a bow-tie diagramme

As indicated on the left side of the bow tie, a reference scenario typically starts with an initiating event (IE) that leads to the critical event (CE), usually the loss of containment.

The right side of the bow tie depicts the development of the scenario (SCE) after the “critical event” leading to the realization of a dangerous phenomenon (DP) or phenomena that produce undesirable consequences. Table 1 below shows typical examples of each of these categories.

**Table 1 Examples of elements of a typical accident scenario**

Initiating Event	Critical Event	Dangerous phenomena	Undesirable consequence
Overpressure	Catastrophic vessel failure	Boiling Liquid Expanding Vapour Explosion (BLEVE)	Employees killed or injured, property damage
Corrosion	Hole in vessel wall	Pool fire	Property damage
Loose flange	Pipe leak	Toxic release	Environmental damage

When selecting accident scenarios for land-use planning, in theory the user would initially derive a number of generic accident scenarios, based only on the substance and the type of installation (e.g. atmospheric, pressurised or cryogenic storage, pipeline, loading/unloading, etc.). These scenarios could be evaluated in a probabilistic or deterministic way using the relevant data and compatibility with existing land uses. If incompatibility between the site and the land-use are found, the user could then review the events leading to the final undesirable outcome of the scenario, to identify opportunities for preventing the critical event or for reducing the impact of events following the critical event. As such, the consequence analysis process is useful tool for not only estimating risk but identifying additional technical measures that could eliminate or reduce the likelihood or consequences of a potential accident scenario.

The European Working Group on Land Use Planning (EWGLUP) agreed on the following principles for the selection of scenarios (Christou et. al., 2006):

- Reference scenarios to be used for estimating consequences as part of the risk analysis process for land-use planning may be selected by the frequency of their occurrence and the severity of their consequences.
- “Worst Case” scenarios are not necessarily the basis for land-use planning, but may rather be considered as a matter of Emergency Planning, further to the requirement to implement best practice or standards to reduce worst case events to a “negligible” frequency.
- The time scale of the consequences of a specific scenario to come into effect shall be considered in the selection.
- According to the chosen level of likelihood for the occurrence of a reference scenario the effectiveness of barriers may be taken into account in the selection.
- Land-use planning is both a prevention and mitigation measure offsite, which requires as a minimum that relevant good practice as published in standards has been implemented onsite.

### **Procedure for Selecting a Scenario for Land-Use or Emergency Planning**

The selection of a scenario to identify risk potential for planning purposes is a simple procedure. The selection should always be based following identification of specific hazard source, which in the case of the Seveso Directive, are fixed establishments where dangerous substances are present in Seveso threshold

**Step 1:** Select the substance relevant to the hazardous establishment.

**Step 2:** With reference to the specific establishment, select the type of installation and examine the conditions (pressure, temperature).

**Step 3:** Get List of scenarios from the Database.

**Step 4:** For each scenario, evaluate the LUP case, according to the selected assessment method and the relevant criteria (as determined by the Seveso competent and planning authorities in the jurisdiction).

**Step 5:** If the risks associated with the particular scenario are incompatible with the land-uses, examine the sequence of events, that is each subevent in the scenario, to identify opportunities for risk reduction.

**Step 6:** Evaluate each subevent, with regards to its frequency or conditions, according to the accepted methods and criteria of the relevant jurisdiction.

**Step 7:** Consider which subevents could be prevented or modified by applying an additional technical measure. Obtain a list of relevant technical measures from the database, together with indications of their reliability and cost.

**Step 8:** Select an appropriate technical measure(s). Re-evaluate the scenario taking into consideration the additional technical measure(s). Repeat from Step 4.

## **1.5 Scenario trees provided in the Handbook**

As a guiding principle, the Handbook aims to provide accident scenario trees for the most relevant types of equipment and dangerous substances. To achieve this objective, the authors conducted research to collect and compare accident scenarios used for land-use planning purposes in the EU Member States, starting with liquefied petroleum gas (LPG), chlorine and ammonia. Following the first phase of collecting information on selected substances, the Group also provided information on liquefied natural gas (LNG), flammable liquids and liquid oxygen.

The JRC analysed the resulting inventory of scenarios to identify similarities and differences. The selection of the definitive scenarios for these substances were based on a consensus of the expert group based on experience that these dangerous substances and pieces of equipment are the most commonly used ones.

The scenario trees are presented in this book by substance with one chapter for each substance. The last chapter describes a case study application of some scenarios presented in the handbook. The scenarios are codified in the form of so-called "scenario trees".

### **Selected Topics of Scenario Trees in the Handbook**

#### **Substances**

- Liquefied petroleum gas (LPG)
- Anhydrous ammonia
- Chlorine
- Liquefied natural gas (LNG)
- Flammable liquids
- Liquefied oxygen

#### **Equipment Type**

- Storage tank
- Pipework
- Pump or pump/compressor
- Loading/unloading arm/hose
- Tank car/wagon
- Carrier

#### **Main critical events associated with the equipment:**

- Instantaneous release/catastrophic rupture/full bore rupture
- Leak

A scenario tree is a taxonomy that shows the most relevant ways an accident involving a certain dangerous substance may happen. It describes the dangerous substance and piece of equipment where the accident may happen, the Critical Event (e.g. leak, catastrophic failure, etc.), the Dangerous Phenomena following this critical event (e.g. toxic gas dispersion, flash-fire, pool-fire, etc.), the Effects (e.g. thermal radiation, overpressure, etc.) and finally possible Causes and Safety Barriers.

The scenarios depicted in the scenario trees in the Handbook contain the main qualitative information with regards to "what can happen". They can be used for land-use or emergency planning decisions as the most relevant scenarios for planning purposes. Quantitative information and data can be added to the qualitative description of the scenarios in order to make them quantifiable.

The Handbook provides a set of accident scenarios as good practice examples. These scenarios describe the conditions that might lead to a major accident and the potential consequences for 6 specific substances or categories of substance and 6 types of equipment. The task group chose the substance and equipment type as the basis of the Handbook scenarios on the basis that:

- 1) They are the most common scenarios required for Seveso land use and emergency planning decisions in EU/EEA countries,
- 2) The basic elements of the scenarios do not vary significantly from country to country
- 3) LOC events for these equipment are described in detail in well-known reference documents, including the Purple Book (CPR 18), the Handbook of Failure Frequencies 2009 (Flemish Government, 2009), and the MIMAH procedure (Delvosalle et.al., 2006).

### **Common features of EU Member State Land-Use Planning Approaches**

- It is acknowledged that there may be substantial differences in the decision making processing associated with land-use planning around Seveso sites. However, there are also a number of commonalities
- Land-use planning policies generally aim to allow hazardous operations – if possible – without imposing any risk to the population outside the fenceline.
- Policies encourage the application of “state-of-the-art” technology to reduce risk at the source
- Development restrictions are generally achieved through specific zoning regulations
- Specific land-use planning decisions typically are made on the basis of relevant accident scenarios
- Absolute “worst case scenarios” are generally not considered appropriate as a basis for land-use planning decisions.
- Land-use planning to fulfill the Seveso Directive obligation is a political decision based on technical advice.

## **1.6 Scenario limitations - Possible physical effects for fires and explosions**

The scenarios present outcomes that can be predicted from release of specific substances under specific circumstances. It should be emphasised here that these scenarios represent the basic structure of a typical scenario involving each substance and associated equipment and processes. It is up to the individual user, depending on the specific facility, equipment and processes involved, to select additional properties necessary for a complete consequence analysis, such as size of release, pipe diameter, wind speed, etc.

Moreover, fires and BLEVEs can produce additional phenomena, that are not depicted in the scenarios presented here, mainly because the generation of additional phenomena depends on individual circumstances at the site. The following figures show the different possible phenomena that can be produced from jet, pool, and flash fires as well as BLEVEs. Users should identify these additional phenomena as possible outcomes of fires and BLEVEs as may be necessary depending on individual properties associated with the site-specific process, equipment and location information.

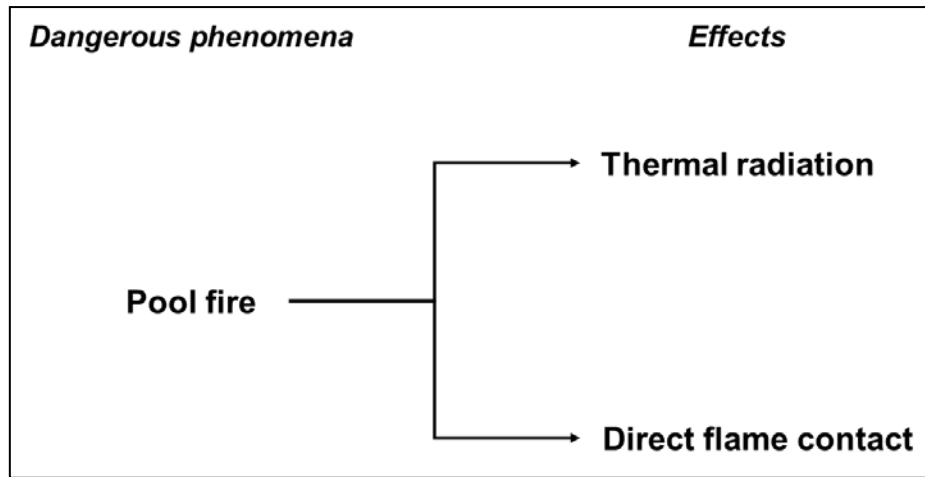

**Figure 2 Physical effects of a pool fire**

**Note:** Only thermal radiation needs to be considered if the area for direct flame contact is contained by the area for thermal radiation.

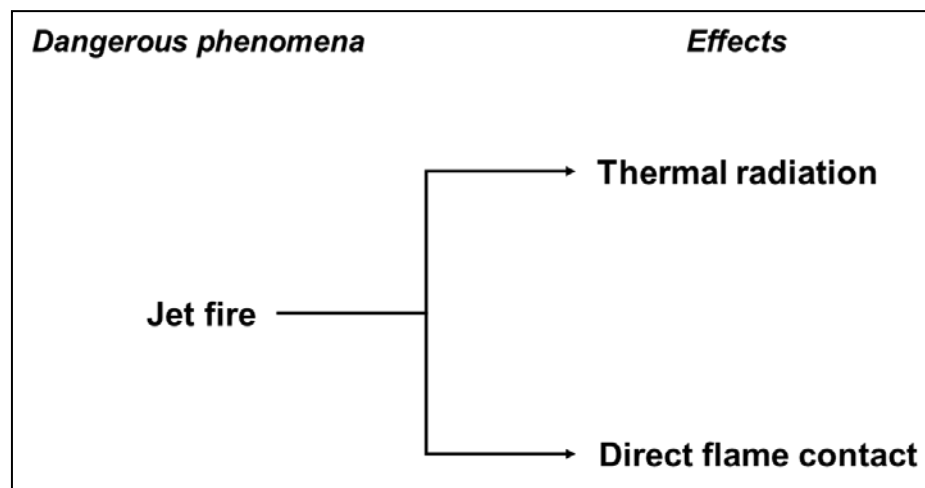

**Figure 3 Physical effects of a jet fire**

**Note:** Only thermal radiation needs to be considered if the area for direct flame contact is contained by the area for thermal radiation.



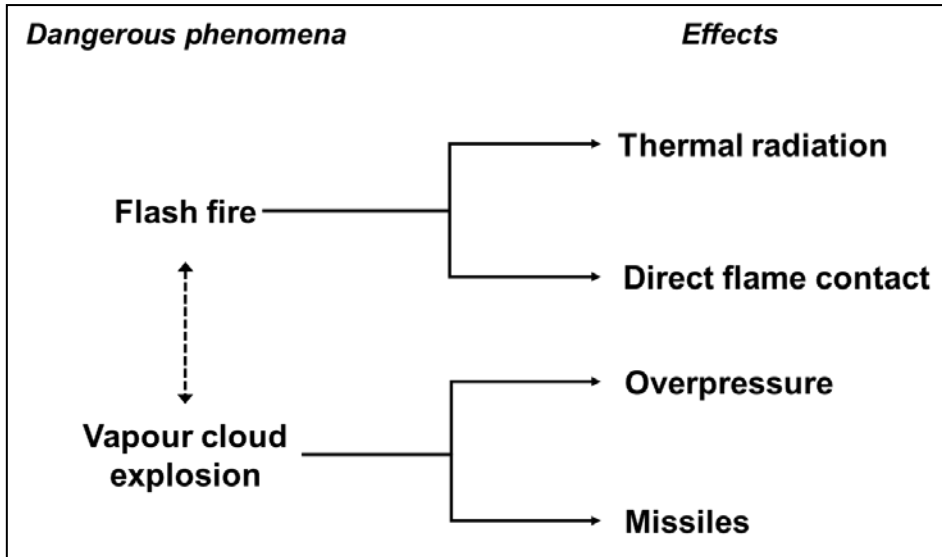

Figure 4 Physical effects of a flash fire and vapour cloud explosion

**Note:**

A vapour cloud explosion may occur in the presence of confined or congested areas. This phenomenon is always accompanied by the flash fire.

For flash fire, it is common practice to only consider direct flame contact. Thermal radiation contours may be slightly larger than the flame footprint, but are hard to calculate due to the dynamics of the combustion of the cloud.

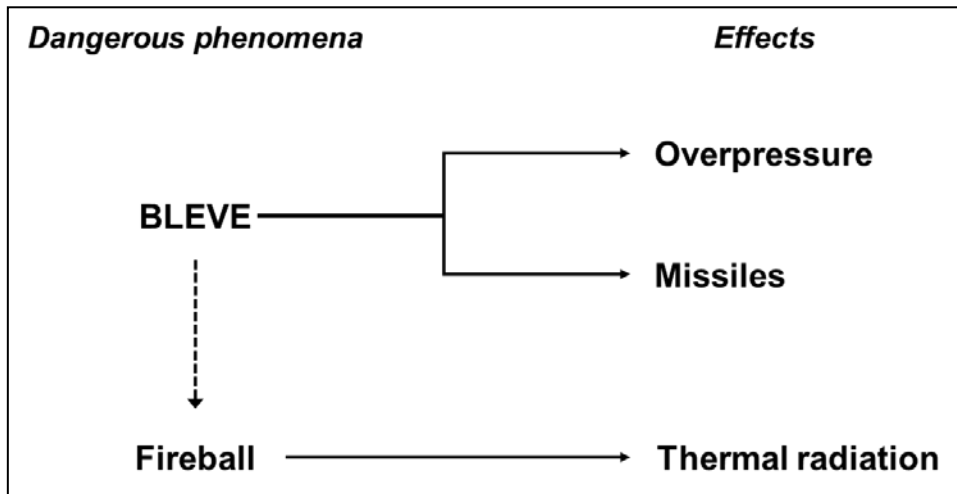

Figure 5 Physical effects of a fireball and BLEVE

**Note:** A BLEVE may occur for flammable and non-flammable substances. For flammable substances, a BLEVE is often accompanied by a fireball.

## 2 Liquefied Petroleum Gas (LPG) Scenarios

This chapter provides scenario trees for Liquefied Petroleum Gas as follows:

- 2.1 LPG above ground pressurised storage tank
- 2.2 LPG pump/compressor
- 2.3 LPG pipework
- 2.4 LPG loading/unloading arm/hose
- 2.5 LPG road tanker/rail tanker

### 2.1 LPG above ground pressurised storage tank

Selected scenarios for LPG storage tank

- 2a Leak in the tank
- 2b Instantaneous release

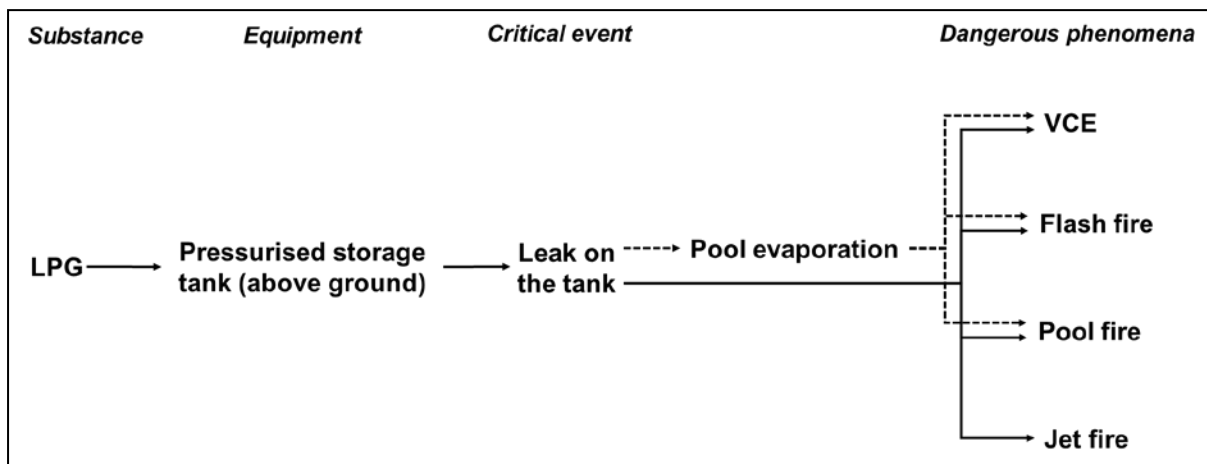

Figure 6 2a Leak in above ground and pressurised LPG storage tank

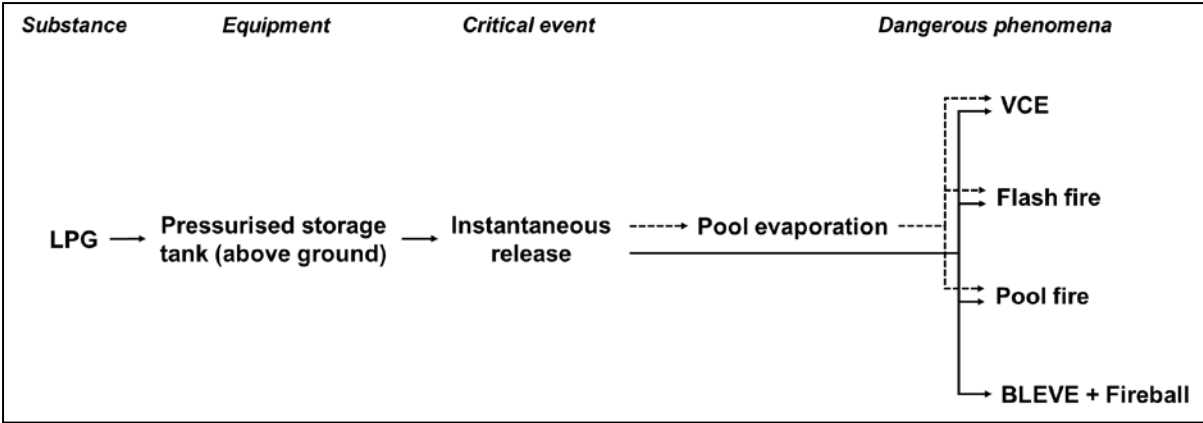

Figure 7 2b Instantaneous release above ground pressurised LPG storage tank

### 2.2 LPG pump/compressor

Selected scenarios for pump/compressor

- 2c Pump/compressor leak
- 2d Pump/compressor catastrophic failure/full bore rupture

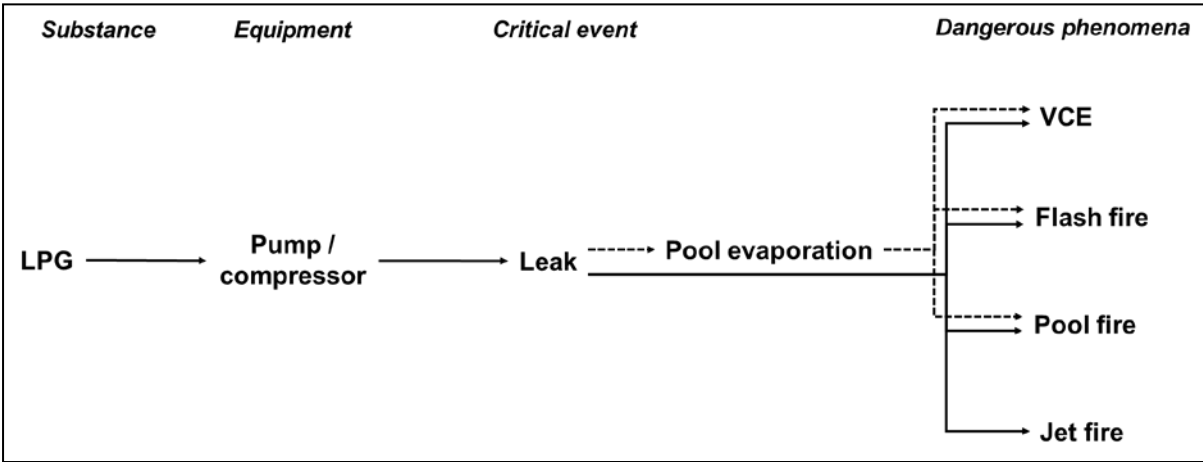

Figure 8 2c LPG pump/compressor leak

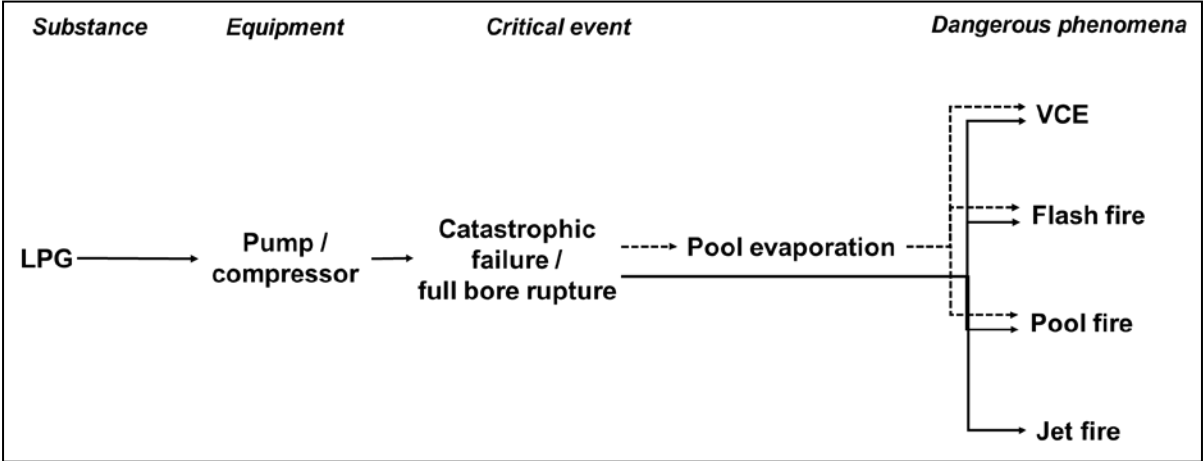

Figure 9 2d LPG pump/compressor catastrophic rupture

## 2.3 LPG Pipework

Selected scenarios for LPG pipework

2e Leak on the pipework

2f Pipework full bore rupture

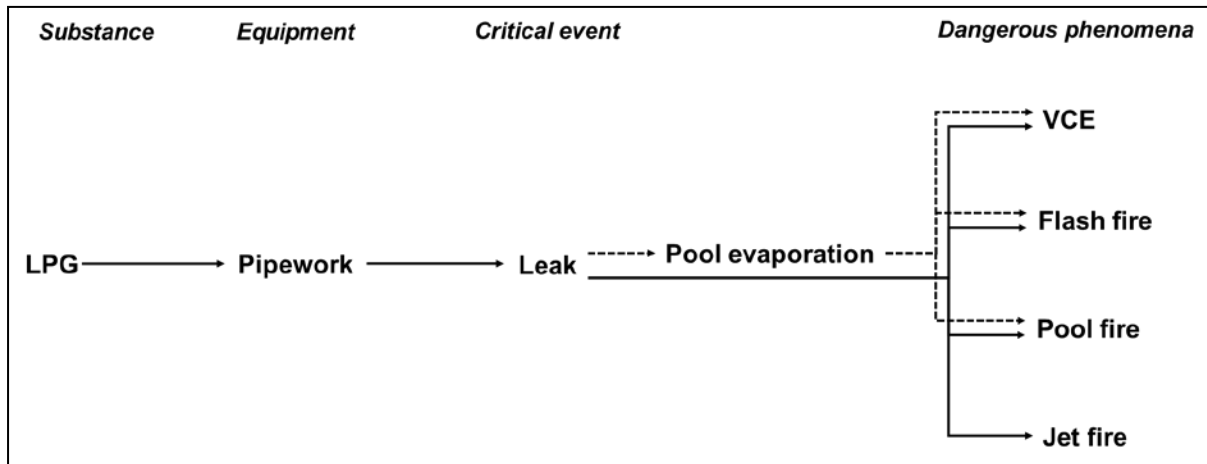

Figure 10 2e LPG leak – pipework

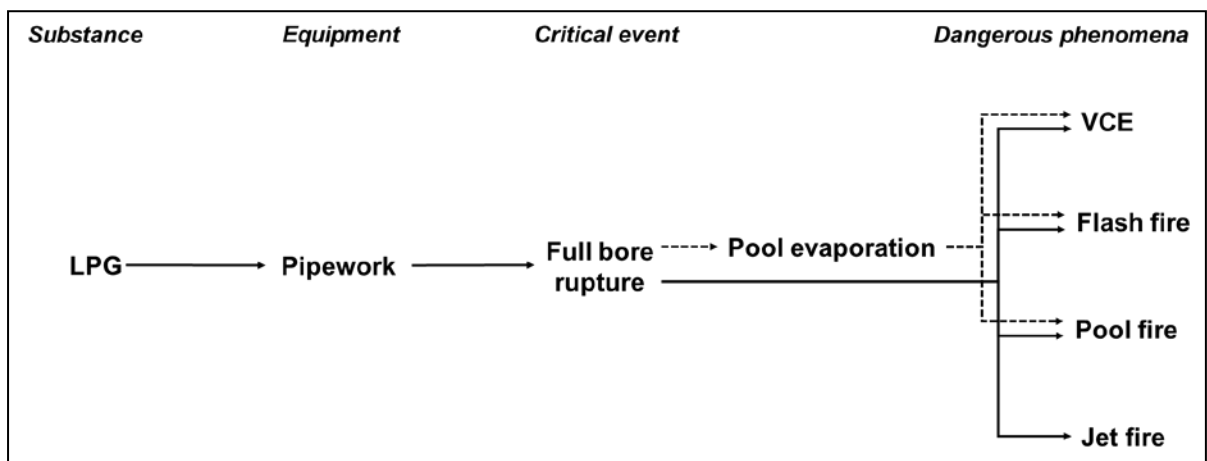

Figure 11 2f Pipework full bore rupture

## 2.4 LPG loading/unloading arm/hose

Selected scenarios for LPG loading/unloading arm/hose

2g Leak on the arm/hose

2h Loading/unloading arm/hose full bore rupture

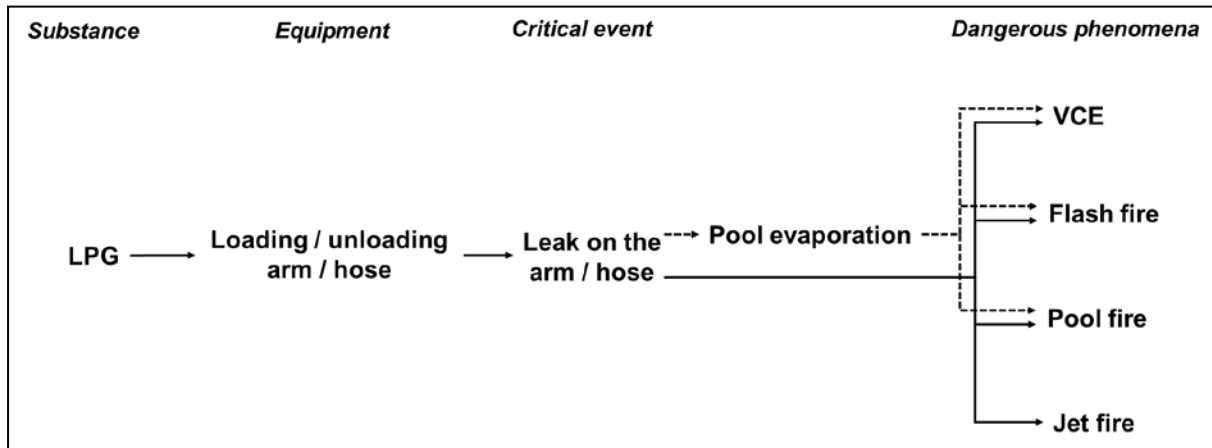

Figure 12 2g Leak LPG loading/unloading arm/hose

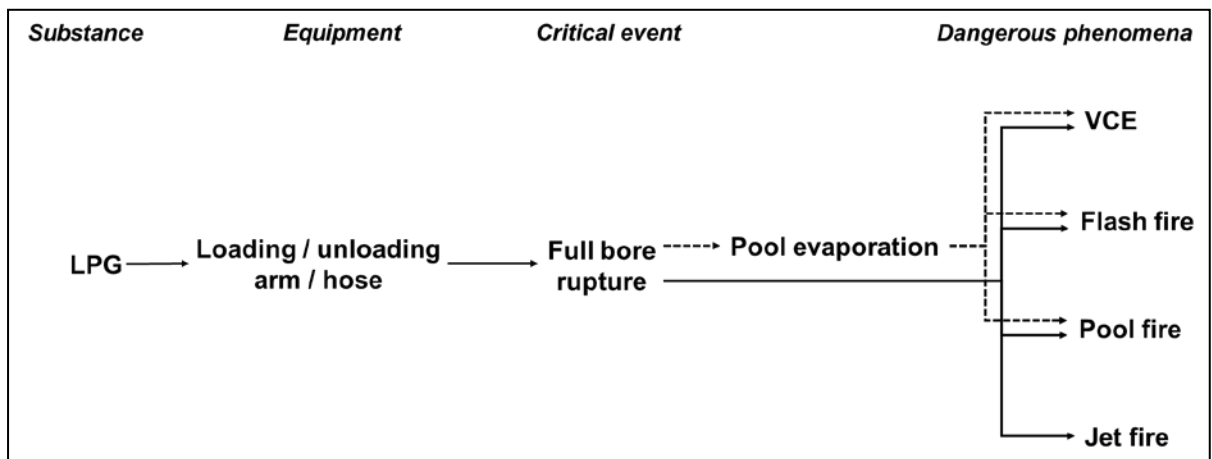

Figure 13 2h LPG loading/unloading arm/hose full bore rupture

## 2.5 LPG road tanker/rail tanker

Selected scenarios for LPG road tanker/rail tanker

- 2i Leak on the road tanker/rail tanker
- 2j Instantaneous release road tanker/rail tanker

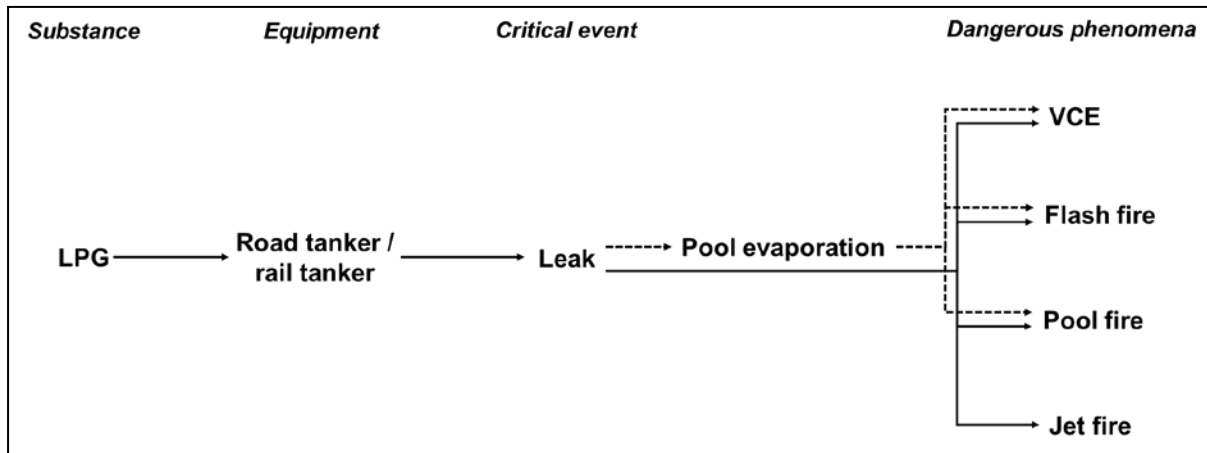

Figure 14 2i 2a Leak on the LPG road tanker/rail tanker

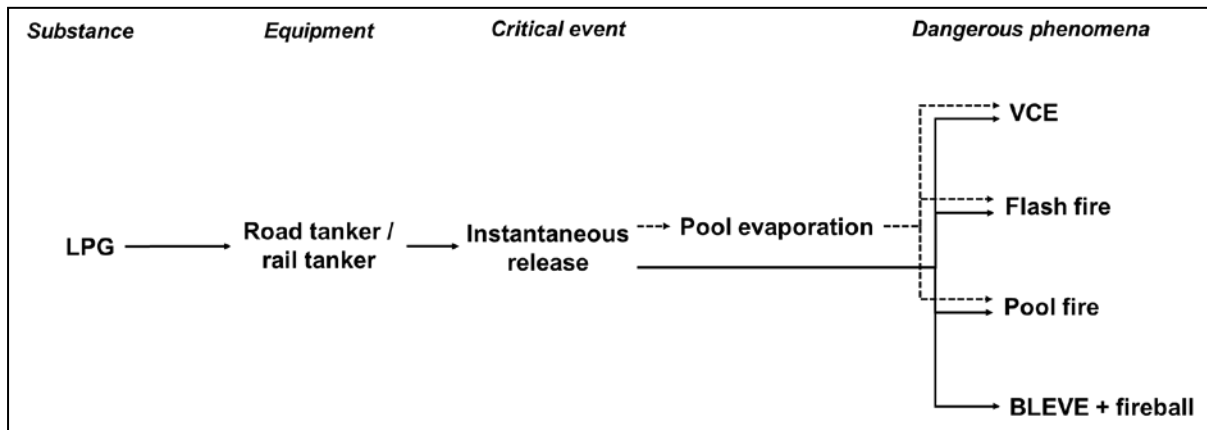

Figure 15 2j LPG instantaneous release road tanker/rail tanker

### 3 Anhydrous ammonia accident scenarios

This chapter provides scenario trees for anhydrous ammonia as follows:

- 3.1 Anhydrous ammonia storage tank
- 3.2 Anhydrous ammonia pump/compressor
- 3.3 Anhydrous ammonia pipework
- 3.4 Anhydrous ammonia loading/unloading arm/hose
- 3.5 Anhydrous ammonia road tanker/rail tanker

Anhydrous ammonia is both toxic and flammable substance. These characteristics should be taken into account in the scenarios.

#### 3.1 Anhydrous ammonia storage tank

Selected scenarios for anhydrous ammonia storage tank

- 3a Anhydrous ammonia storage tank - pressurised at ambient temperature
- 3b Anhydrous ammonia storage tank - atmospheric pressure refrigerated

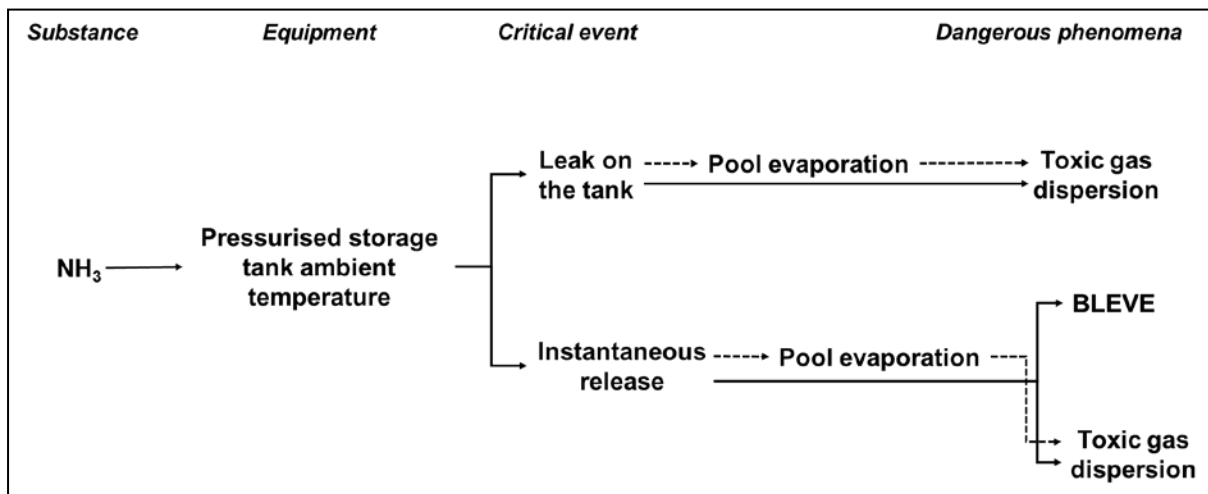

Figure 16 3a Scenarios for anhydrous ammonia storage tank pressurised at ambient temperature

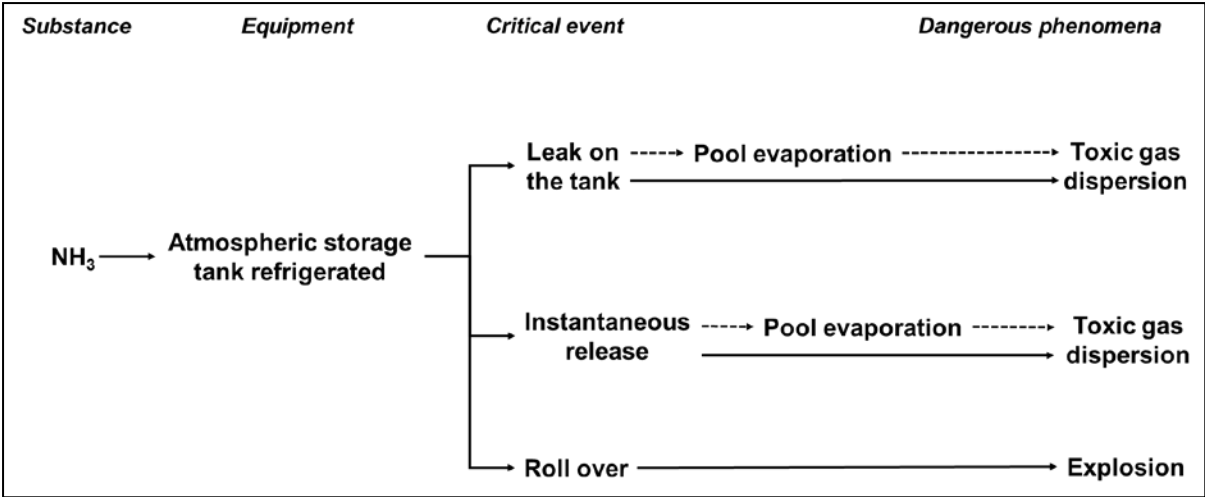

Figure 17 3b Scenarios for anhydrous ammonia atmospheric pressure refrigerated storage tank

### 3.2 Anhydrous ammonia pump/compressor

- Selected scenarios for anhydrous ammonia pump/compressor
- 3c Leak pump/compressor
- 3d Pump/compressor catastrophic failure/full bore rupture

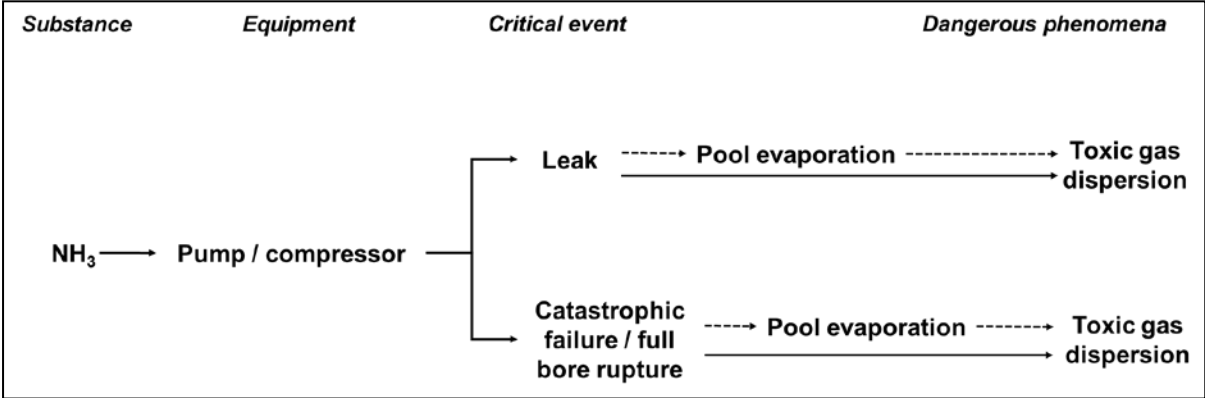

Figure 18 3c-d Scenarios for anhydrous ammonia pump/compressor



### 3.3 Anhydrous ammonia pipework

Selected scenarios for anhydrous ammonia pipework

- 3e Leak on the pipework
- 3f Pipework full bore rupture

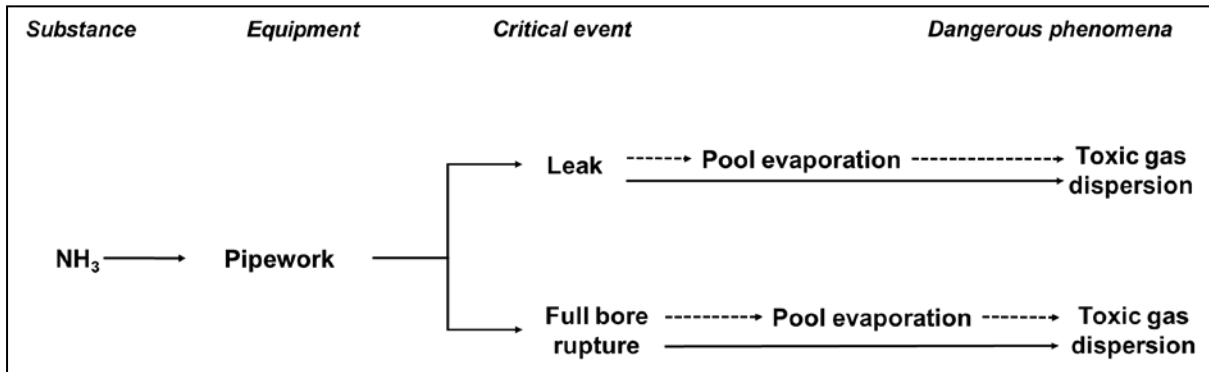

Figure 19 3e-f Scenarios for anhydrous ammonia pipework

### 3.4 Anhydrous ammonia loading/unloading arm/hose

Selected scenarios for anhydrous ammonia loading/unloading arm/hose

- 3g Leak on the arm/hose
- 3h Loading /unloading arm/hose full bore rupture

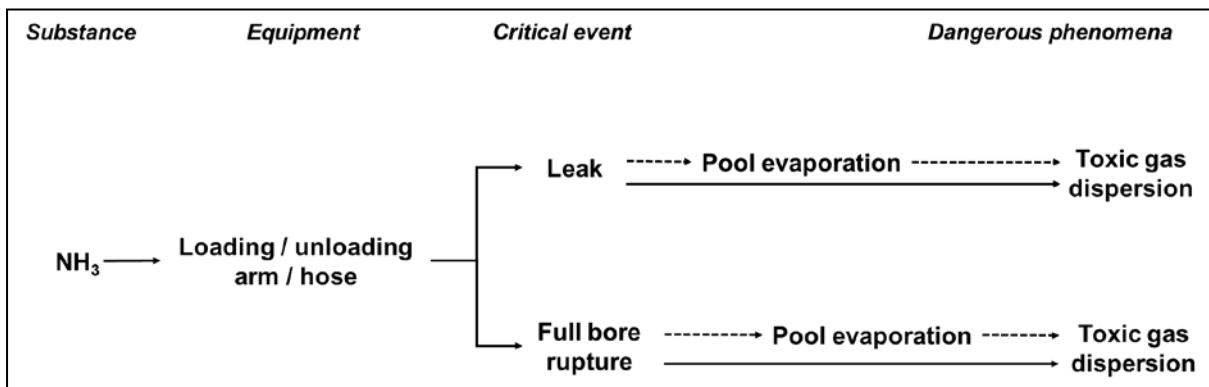

Figure 20 3g-h Scenarios for anhydrous ammonia loading/unloading arm/hose

### 3.5 Anhydrous ammonia road tanker/rail tanker

Selected scenarios for anhydrous ammonia road tanker/rail tanker

- 3i Leak on the road tanker/rail tanker
- 3j Instantaneous release road tanker/rail tanker

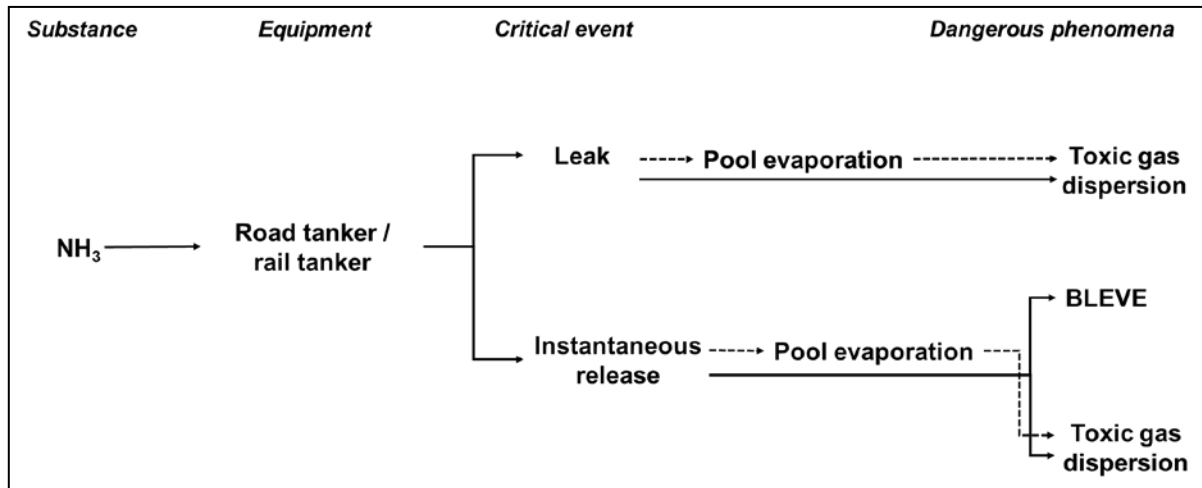

Figure 21 3i-j Scenarios for anhydrous ammonia road tanker/rail tanker

## 4 Chlorine Accident Scenarios

This chapter provides scenario trees for chlorine as follows:

- 4.1 Chlorine above ground pressurised storage tank
- 4.2 Chlorine pump/compressor
- 4.3 Chlorine pipework
- 4.4 Chlorine loading/unloading arm/hose
- 4.5 Chlorine road tanker/rail tanker

### 4.1 Chlorine above ground pressurised storage tank

Selected scenarios for chlorine storage tank

- 4a Leak on the tank
- 4b Instantaneous release

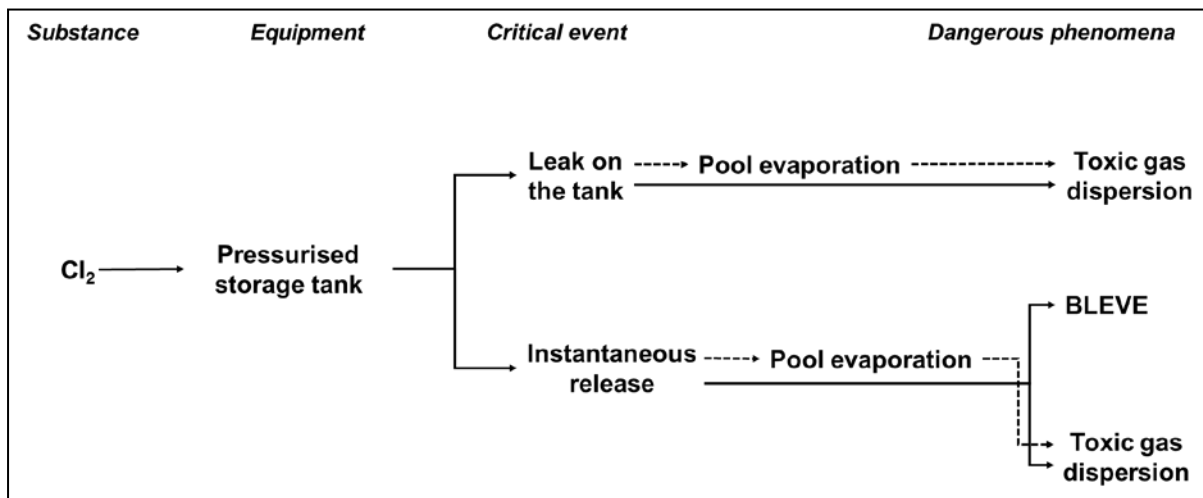

Figure 22 4a-b Scenarios for chlorine pressurised storage tank

## 4.2 Chlorine pump/compressor

Selected scenarios for chlorine pump/compressor

4c Leak pump/compressor

4d Pump/compressor catastrophic failure/full bore rupture

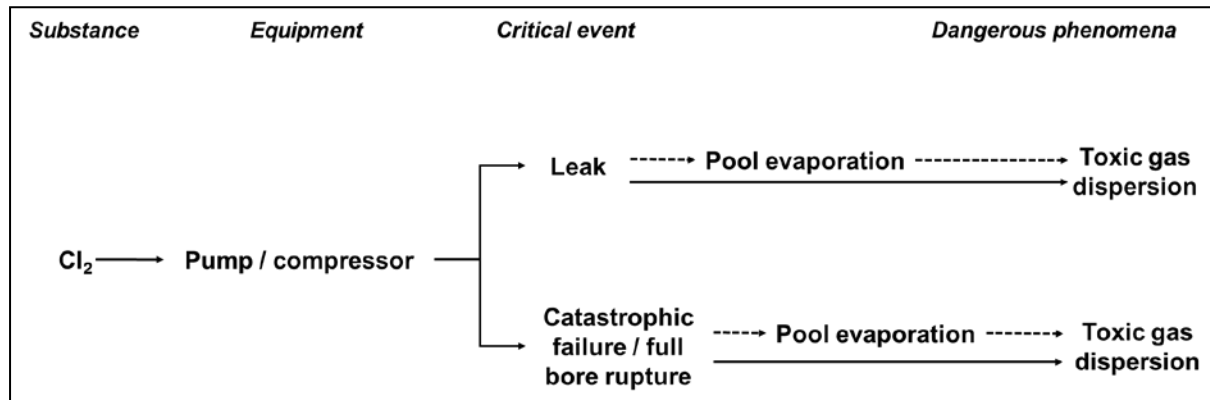

Figure 23 4c-d Scenarios for chlorine pump/compressor

## 4.3 Chlorine pipework

Selected scenarios for Chlorine pipework

4e Leak on the pipework

4f Pipework full bore rupture

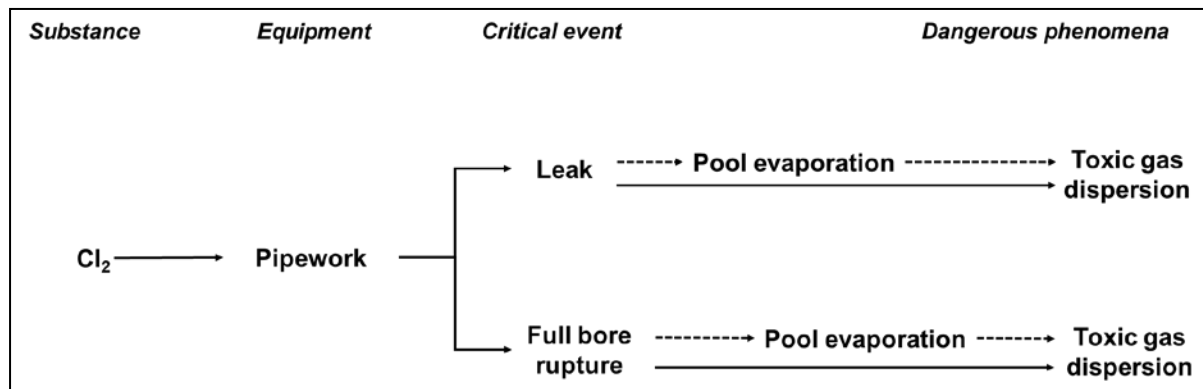

Figure 24 4e-f Scenarios for chlorine pipework

#### 4.4 Chlorine loading/unloading arm/hose

Selected scenarios for Chlorine loading/unloading arm/hose

- 4g Leak on the arm/hose
- 4h Loading/unloading arm/hose full bore rupture

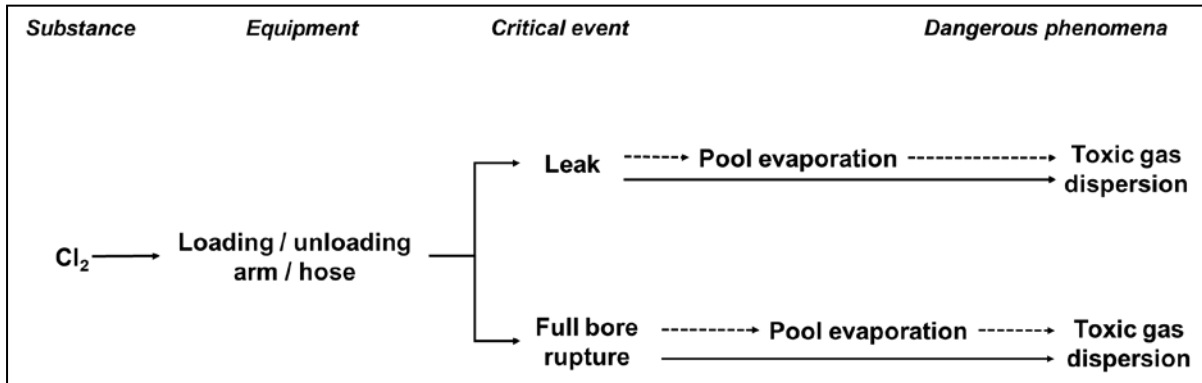

Figure 25 4g-h Scenarios for chlorine loading/unloading arm/hose

#### 4.5 Chlorine road tanker/rail tanker

Selected scenarios for Chlorine road tanker/rail tanker

- 4i Leak on the road tanker/rail tanker
- 4j Instantaneous release road tanker/rail tanker

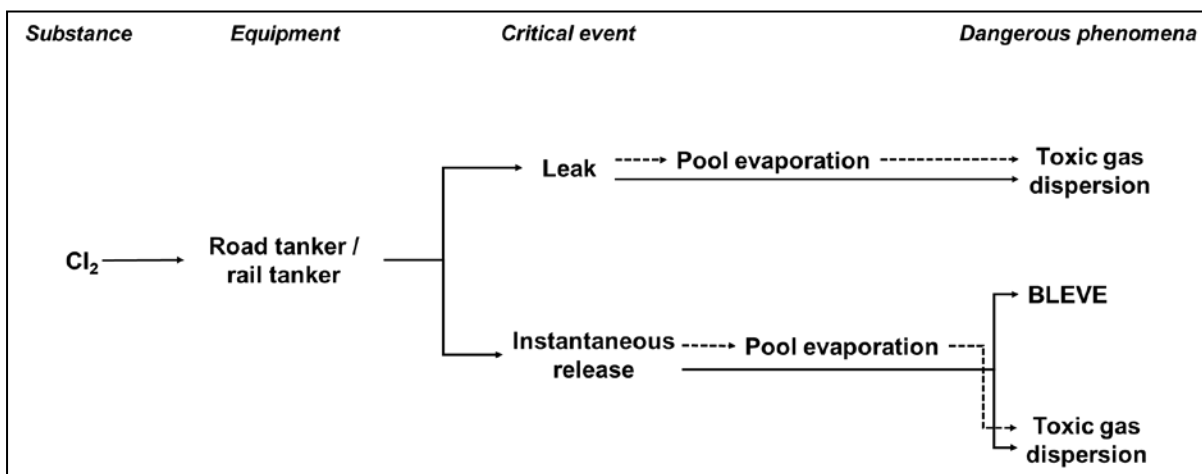

Figure 26 4i-j Scenarios for chlorine road tanker/rail tanker

## 5 Liquefied Natural Gas (LNG) Accident Scenarios

This chapter provides scenario trees for liquefied natural gas (LNG) as follows:

- 5.1 Liquefied natural gas cryogenic atmospheric storage tank
- 5.2 LNG pump/compressor
- 5.3 LNG pipework
- 5.4 LNG loading/unloading arm/hose
- 5.5 LNG road tanker/rail tanker

### 5.1 Liquefied natural gas cryogenic atmospheric storage tank

Selected scenarios for LNG storage tank

- 5a Leak on the tank
- 5b Instantaneous release
- 5c Roll over
- 5d Roof collapse

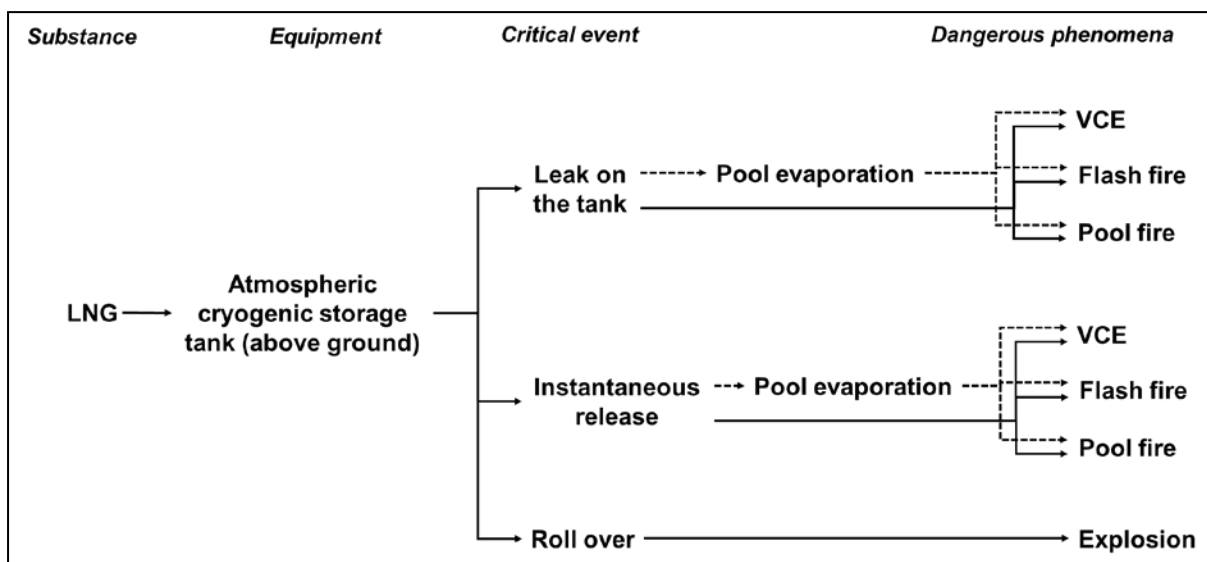

Figure 27 5a-b-c Scenarios for LNG cryogenic atmospheric storage tank

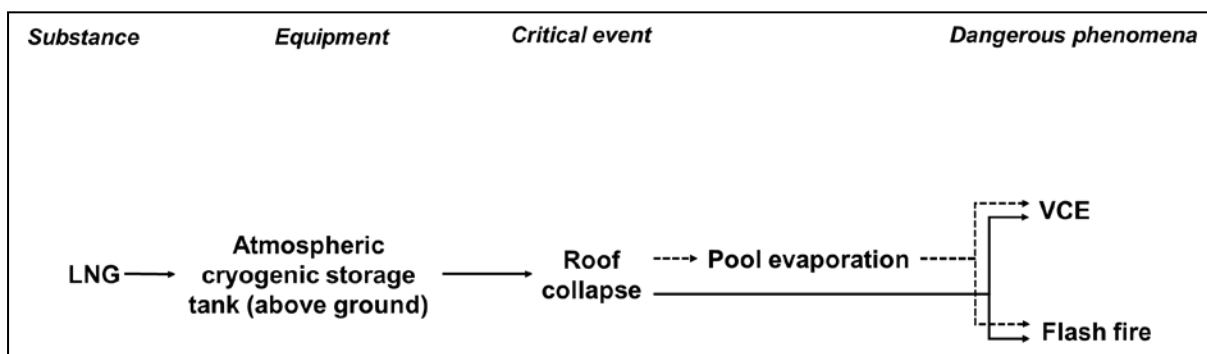

Figure 28 5d Roof collapse LNG cryogenic atmospheric cryogenic storage tank

## 5.2 LNG pump/compressor

Selected scenarios for LNG pump/compressor

5e Leak pump/compressor

5f Pump/compressor catastrophic failure/full bore rupture

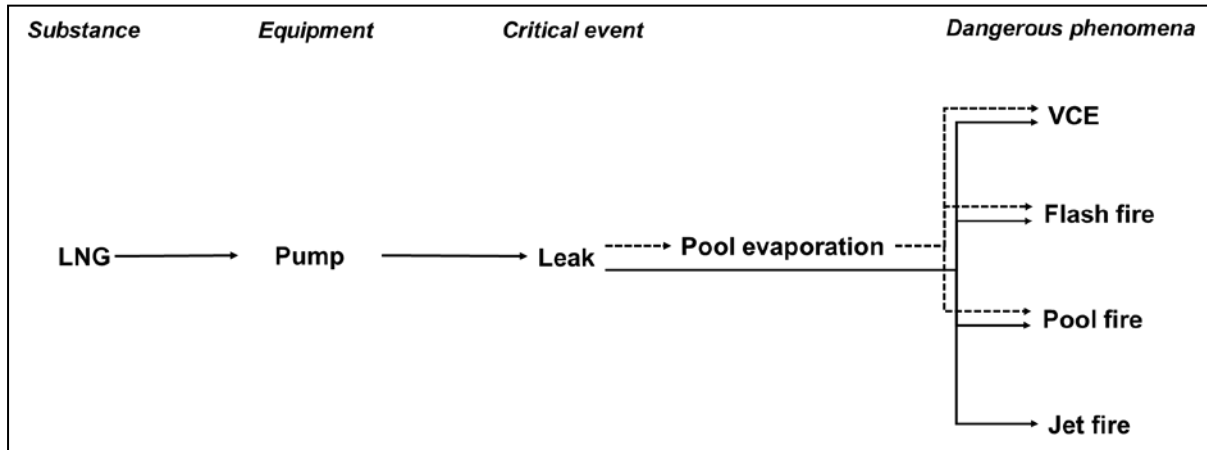

Figure 29 5e LNG pump/compressor leak

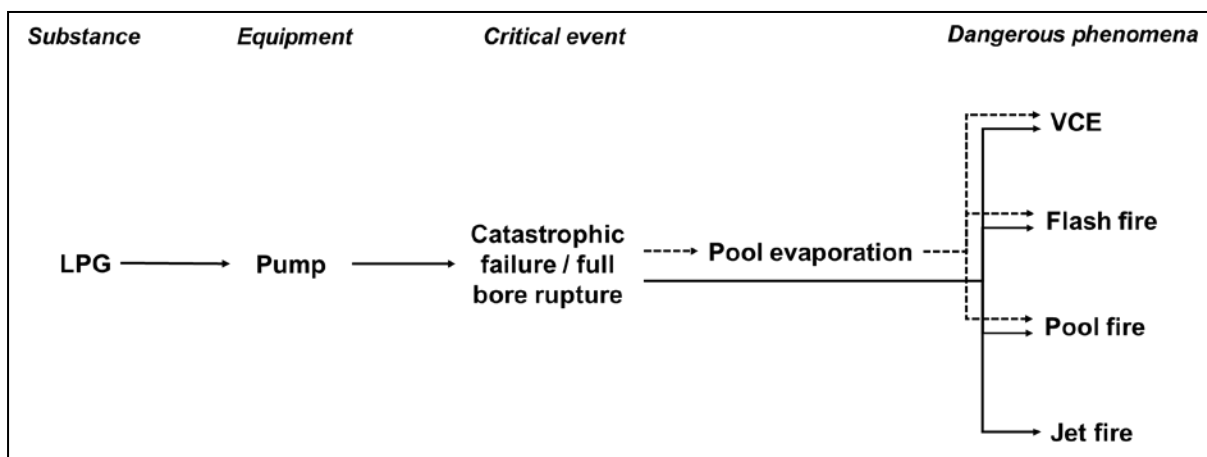

Figure 30 5f LNG pump/compressor catastrophic failure/full bore rupture

### 5.3 LNG pipework

Selected scenarios for LNG pipework

5g Leak on the pipework

5h Pipework full bore rupture

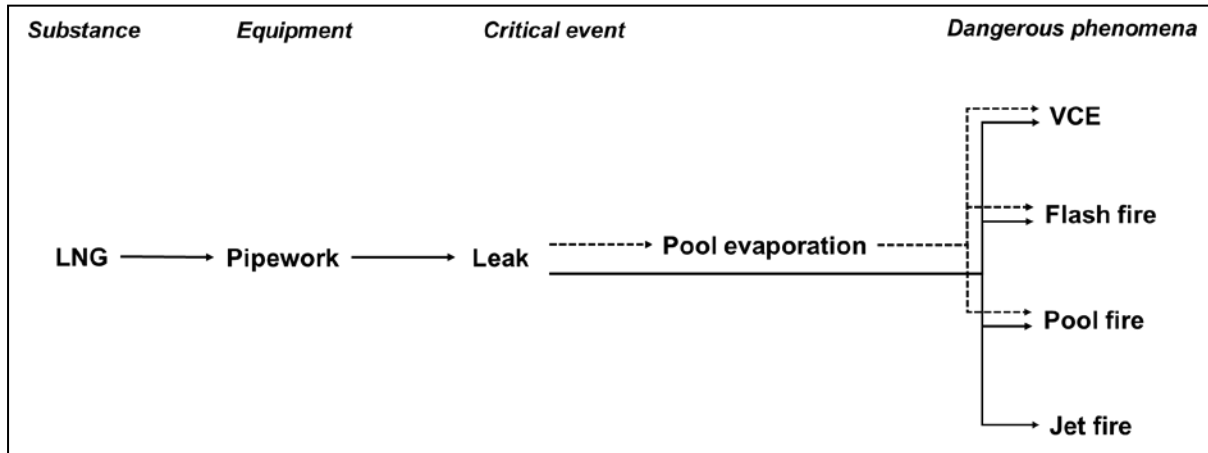

Figure 31 5g Leak LNG pipework

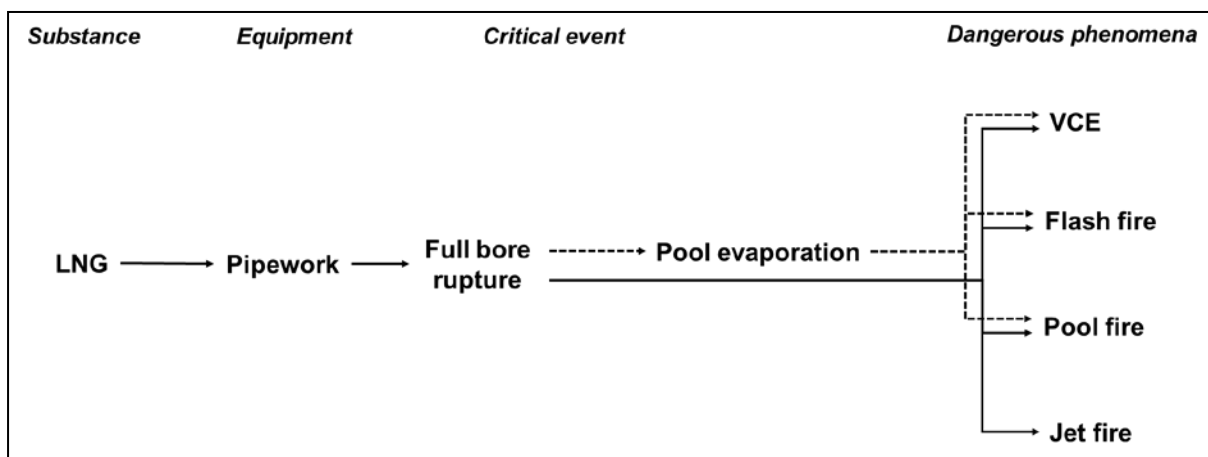

Figure 32 5h LNG pipework full bore rupture





## 5.5 LNG road tanker/rail tanker

Selected scenarios for LNG road tanker/rail tanker

- 5k Leak on the road tanker/rail tanker
- 5l Instantaneous release road tanker/rail tanker
- 5m Leak and roll over LNG carrier
- 5n Instantaneous release LNG carrier

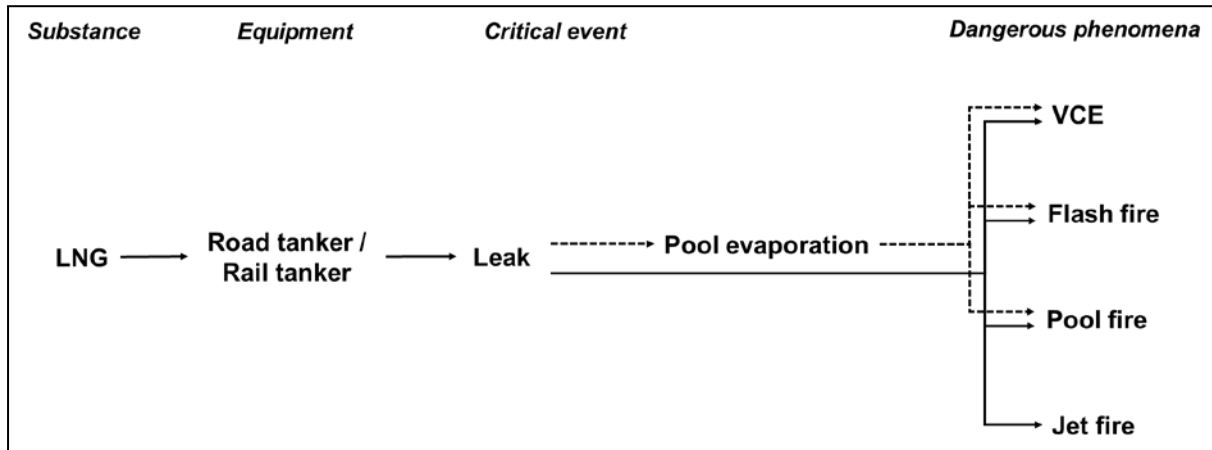

Figure 35 5k Leak LNG road tanker/rail tanker

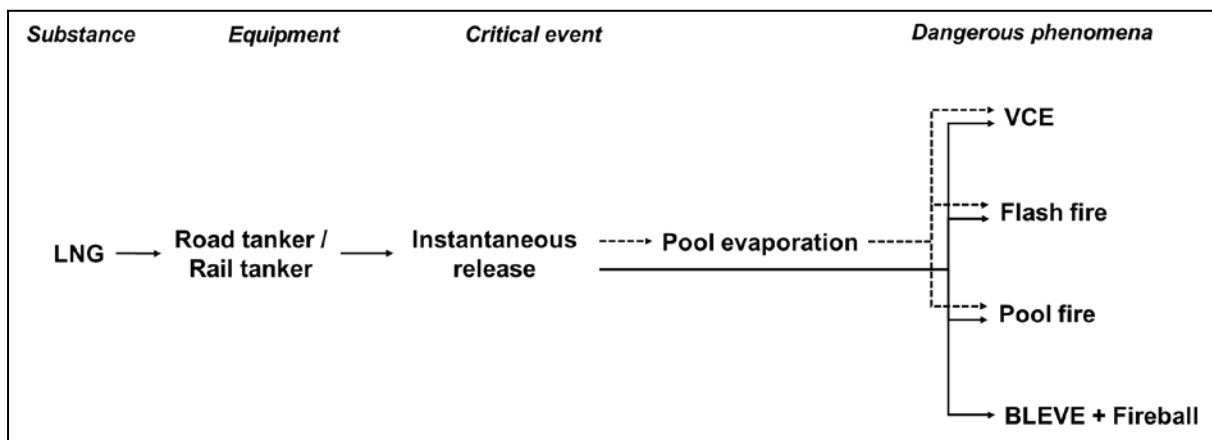
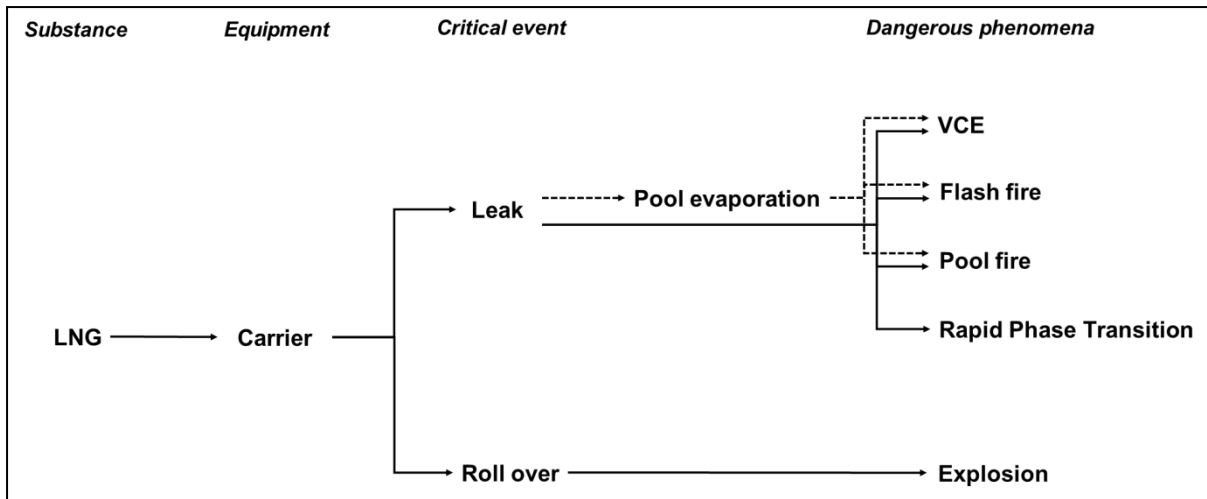
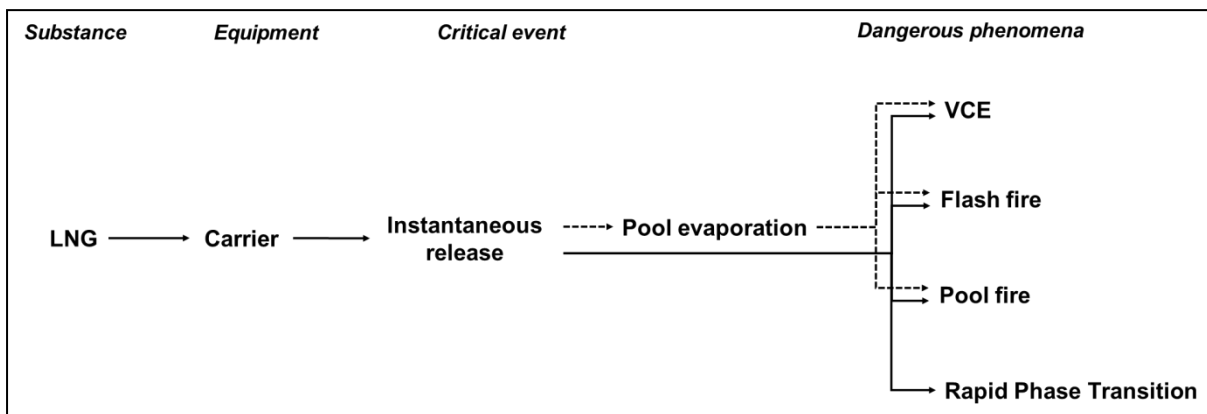

Figure 36 5l LNG road tanker/rail tanker instantaneous release



**Figure 37 5m Leak and roll over - LNG carrier**

**Note:** A “roll-over” in an LNG tank can occur if the liquid at the bottom becomes lighter than that at the top, and rapidly rises to the surface. The liquid that moves to the top of the container experiences a drop in pressure equal, to a first approximation, to the head of liquid. It may therefore be above its boiling point at that pressure. In such an event the vapour pressure within the tank may be as high as the liquid pressure at the bottom of the tank, whence the liquid came, and so the resulting pressure spike might overwhelm the pressure relief systems in place and if pipe work is not designed, constructed and maintained to cope with these then this might fail.



**Figure 38 5n Instantaneous release LNG carrier**

## 6 Flammable Liquids Accident Scenarios

This chapter provides scenario trees for flammable liquids as follows:

- 6.1 Flammable Liquid atmospheric storage tank
- 6.2 Flammable Liquid pump
- 6.3 Flammable Liquid pipework
- 6.4 Flammable Liquid loading/unloading arm/hose
- 6.5 Flammable Liquid road tanker/rail tanker

### 6.1 Flammable Liquid atmospheric storage tank

Selected scenarios for Flammable Liquid atmospheric storage tank

- 6a Leak on the tank
- 6b Instantaneous release
- 6c Collapse of the roof – floating roof only

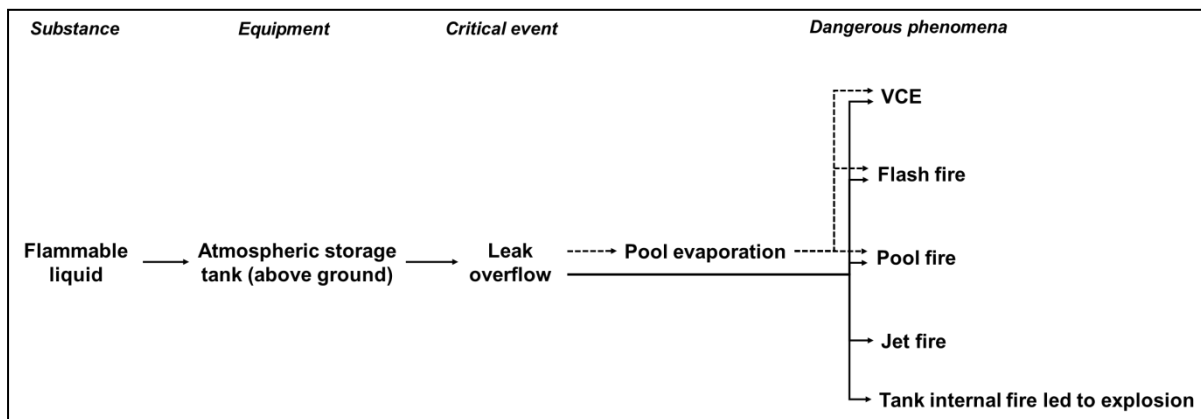

Figure 39 6a Leak on the flammable liquid atmospheric storage tank

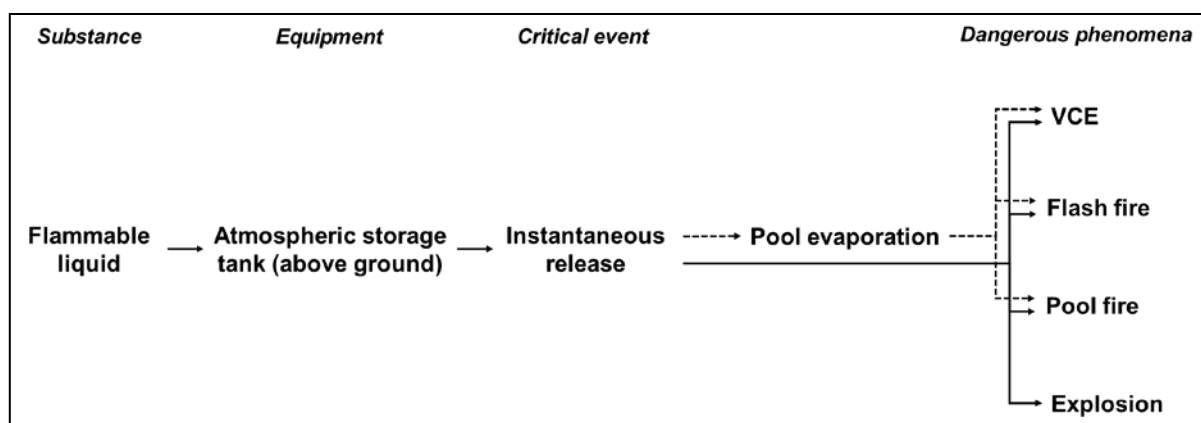

Figure 40 6b Instantaneous release flammable liquid atmospheric storage tank

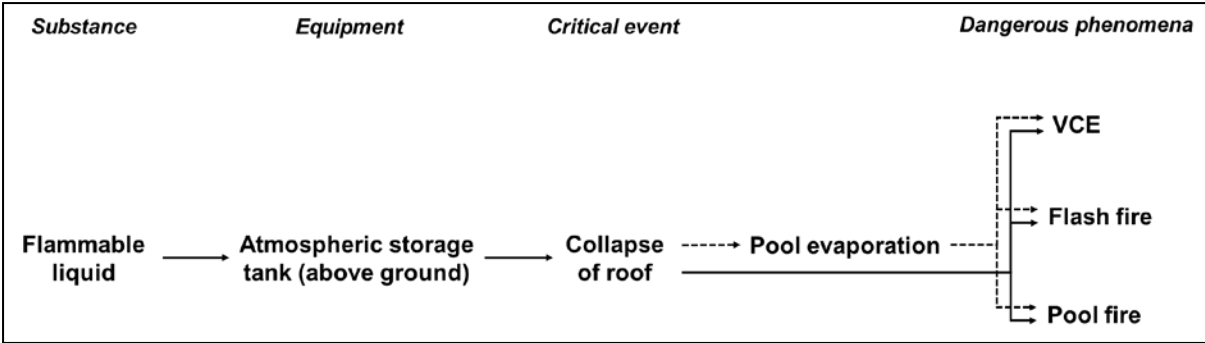

Figure 41 6c Collapse of roof - Flammable Liquid atmospheric storage tank with floating roof

### 6.2 Flammable liquid pump

Selected scenarios for Flammable liquid pump

6d Leak pump

6e Pump catastrophic failure/full bore rupture

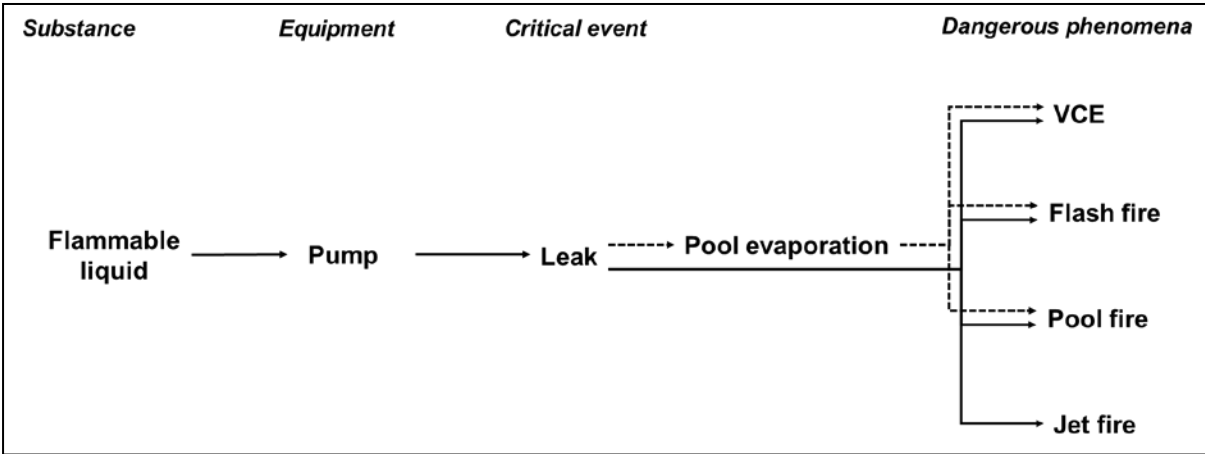

Figure 42 6d Flammable liquid pump leak

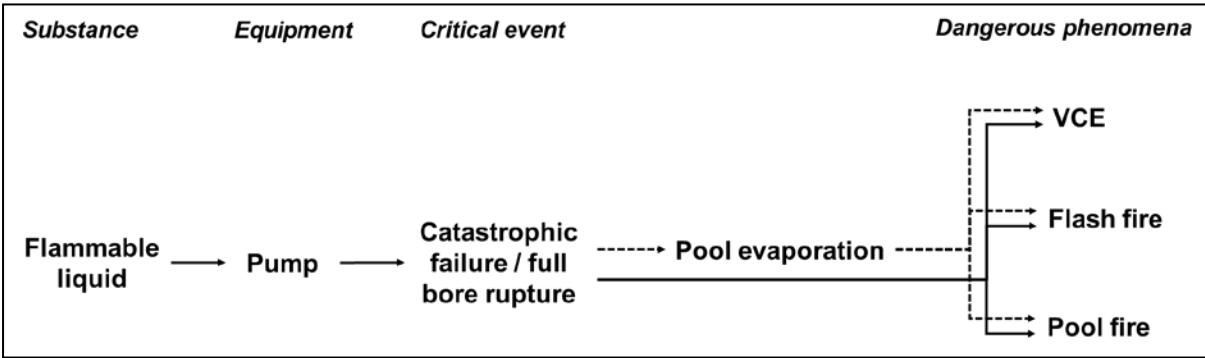

Figure 43 6e Flammable liquid pump catastrophic failure/full bore rupture

### 6.3 Flammable liquid pipework

Selected scenarios for flammable liquid pipework

6a Leak on the pipework

6b Pipework full bore rupture

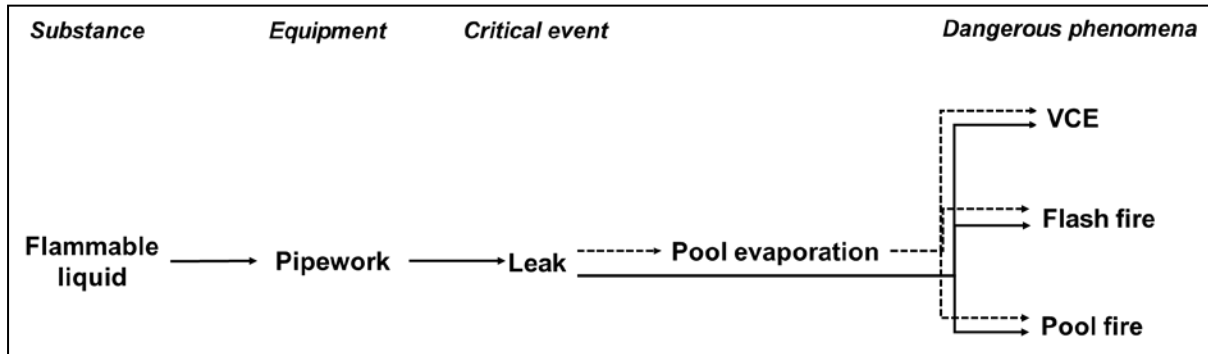

Figure 44 6f Leak- flammable liquid pipework

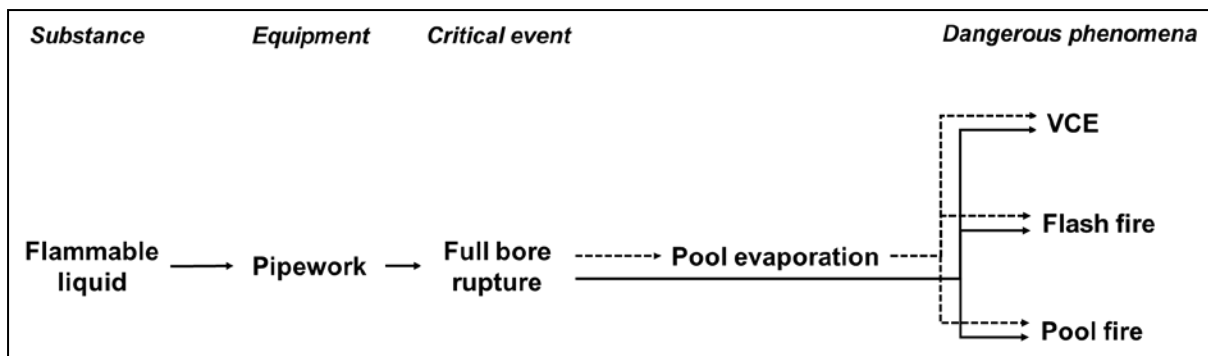

Figure 45 6g Flammable liquid pipework full bore rupture

## 6.4 Flammable Liquid loading/unloading arm/hose

Selected scenarios for Flammable Liquid loading/unloading arm/hose

6h Leak on the arm/hose

6i Loading/unloading arm/hose full bore rupture

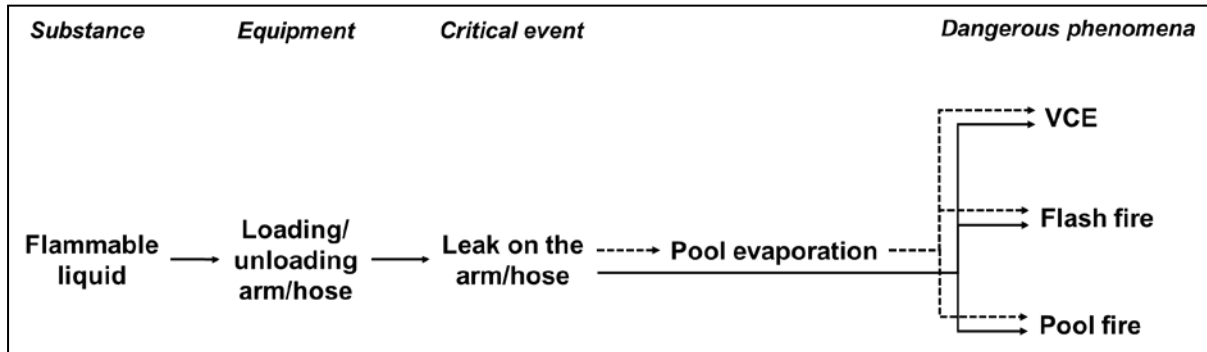

Figure 46 6h Leak on the Flammable Liquid loading/unloading arm/hose

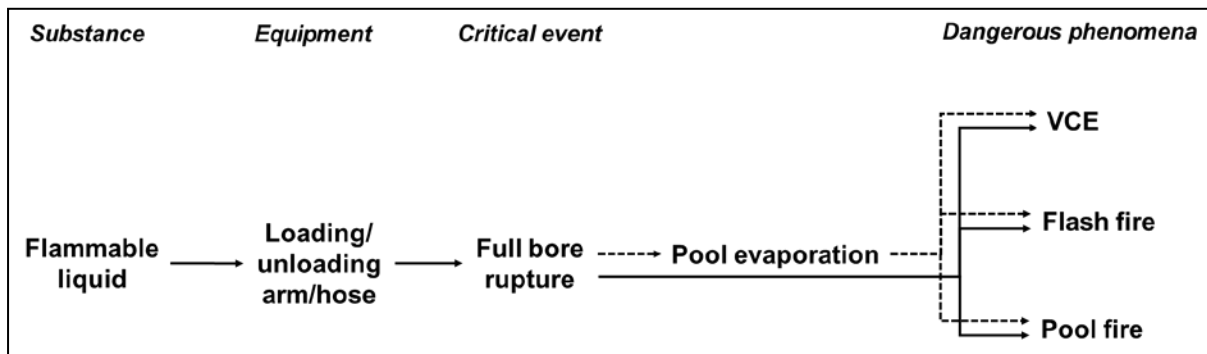

Figure 47 6i Flammable liquid loading/unloading arm/hose full bore rupture

## 6.5 Flammable liquid road tanker/rail tanker

Selected scenarios for Flammable Liquid road tanker/rail tanker

6j Leak on the road tanker/rail tanker

6k Instantaneous release road tanker/rail tanker

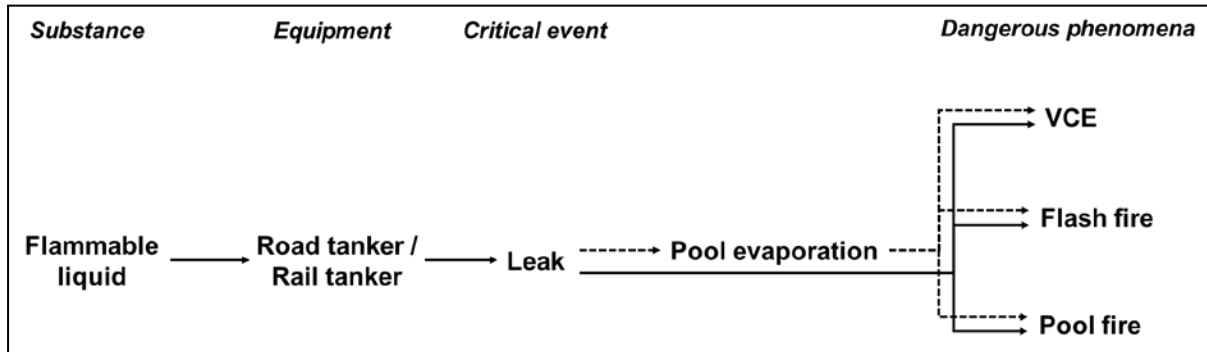

Figure 48 6j Leak on the flammable liquid road tanker/rail tanker

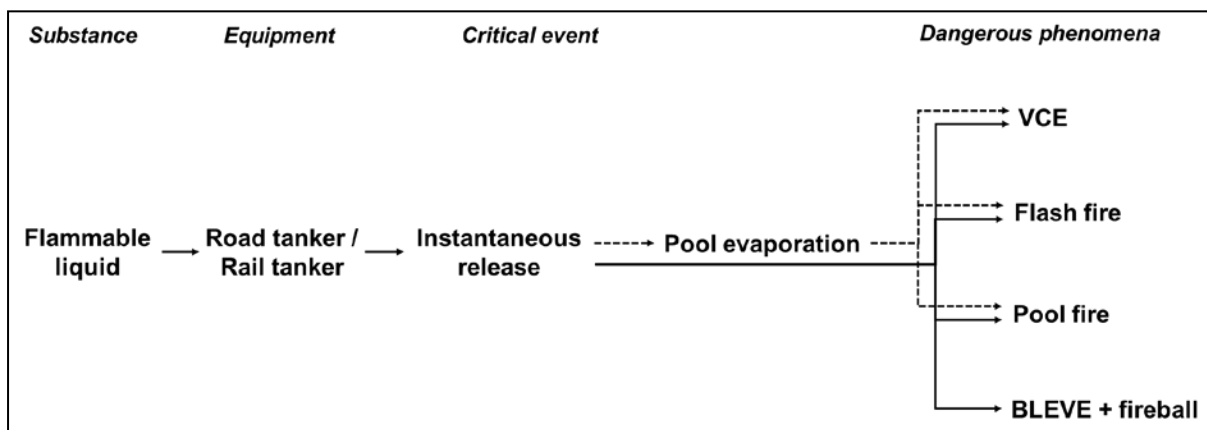

Figure 49 6k Instantaneous release from a flammable liquid road tanker/rail tanker



## 7 Liquefied Oxygen Accident Scenarios

This chapter provides scenario trees for liquefied oxygen as follows:

- 7.1 Liquefied oxygen cryogenic storage tank
- 7.2 Liquefied oxygen pump
- 7.3 Liquefied oxygen pipework
- 7.4 Liquefied oxygen loading/unloading arm/hose

### 7.1 Liquefied oxygen cryogenic storage tank

Selected scenarios for liquefied oxygen cryogenic storage tank

- 7a Leak on the tank
- 7b Instantaneous release

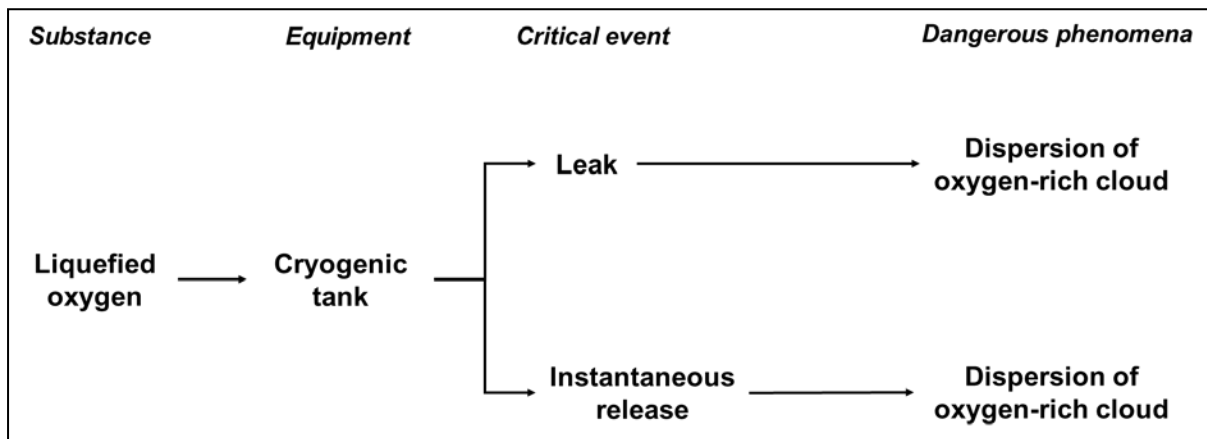

Figure 50 7a-b Scenarios liquefied oxygen cryogenic tank

## 7.2 Liquefied oxygen pump

Selected scenarios for liquefied oxygen pump

7c Leak pump

7d Pump catastrophic failure/full bore rupture

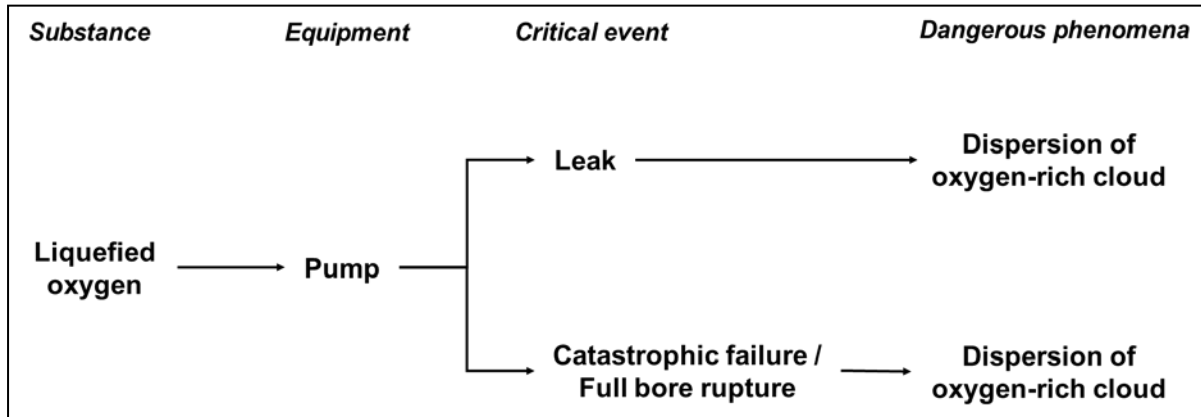

Figure 51 7c-d Scenarios for liquefied oxygen pump

## 7.3 Liquefied oxygen pipework

Selected scenarios for liquefied oxygen pipework

7e Leak on the pipework

7f Pipework full bore rupture

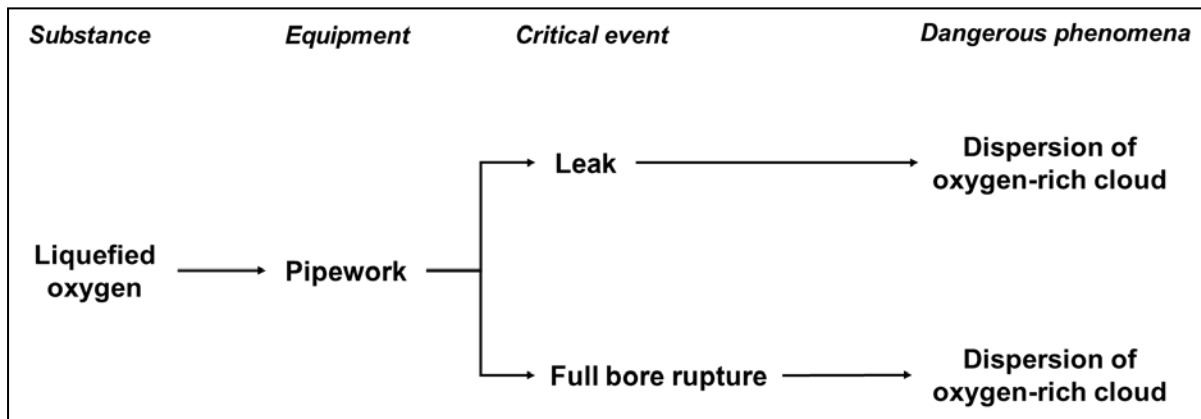

Figure 52 7e-f Scenarios for LOX pipework

## 7.4 Liquefied oxygen loading/unloading arm/hose

Selected scenarios for LOX loading/unloading arm/hose

7g Leak on the arm/hose

7h Loading/unloading arm/hose full bore rupture

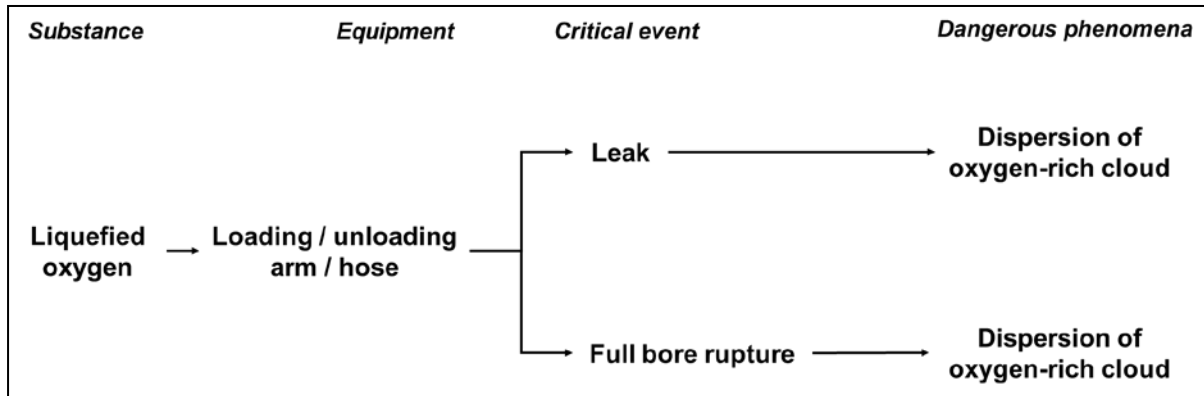

Figure 53 7g-h Scenarios for liquefied oxygen loading/unloading arm/hose

## 8 Case Studies Using the Scenario Trees

This chapter presents a case study performed by the Task Force that demonstrates the scenario trees in this handbook can be used in a risk assessment procedures to support land-use and emergency planning. The specific research objectives of the case study were:

- To highlight similarities and understand differences among the different national approaches against the same study case; and
- To evaluate the functionality of the scenario trees as an inventory of good practices for assessing land-use planning cases.

The case study results also aimed to show that different risk assessment and decision-making procedures will produce different results even if the same scenario is applied.

The case study therefore consisted of involving experts from representatives from different countries to apply the same scenarios to the same (fictitious) facilities using their own risk assessment procedure (a standardised approach determined at national level in each country) to the case study. They also were to apply the relevant national or regional decision-making procedure for land-use planning to the results to achieve a land-use planning recommendation for the fictitious case study.

The case study was centred on two fictitious facilities, one that handled and stored chlorine and one that handled and stored LPG. These two reference substances and facilities were selected because (1) chlorine and LPG are commonly used substances in industrial processes and (2) these types of facilities use standardised processes and are therefore are fairly similar across the European Union. For each facility, the layout (location of equipment, size of buildings and storage areas, etc.) was pre-defined for use in the case study. Specific land-use planning questions were also selected to analyse and apply the results of the risk assessment in different national contexts (i.e., using national land-use planning decision-making procedures).

It is worth stressing that the purpose of the study was not to rank the different land-use planning approaches against any particular criterion - for instance - their effectiveness. Rather, the goal of this work was to collect data, learn more about how the national methodologies work in practice, and analyse the outcomes. It was expected that this new information could assist other countries and regions in developing land-use planning policies in the context of the Seveso Directive.

The case study was carried out by 8 participants representing EU Member States or European Autonomous Regions, as follows:

- Belgium – Flemish Region (SGS)
- Belgium - Flemish Region (BARN)
- Belgium – Walloon Region
- Catalonia
- France
- Italy
- The Netherlands
- United Kingdom

The exercise asked what land-use planning decision that an authority in the relevant country would take based on the results of the risk assessment associated with the fictitious sites for the following situations:

- new small residential developments (blocks of 3 houses) located at distances of 200m; 300m; 400m; 500m; 600m; 700m; 800m and 900m from the plant
- a school located at 1000m from the plant
- office areas located at 200m and 800m from the plant.

The teams used the following risk assessment approaches:

P1: Quantitative approach

P2: Semi-quantitative approach

P3: Quantitative approach

P4: Quantitative approach

P5: Quantitative approach

P6: Quantitative approach

P7: Quantitative approach

P8: Semi-quantitative approach

In the sections that follow the two cases are described, and the results of the analysis are presented and compared. In addition, the assessments from 2 Member States are described in depth to illustrate specifically how the scenario trees were used to reach land-use planning decisions.

## 8.1 The chlorine facility case study

The chlorine case study features an unloading operation at a chlorine facility. Figure 54 shows how the chlorine installation of the establishment is linked to the road tanker for unloading a chlorine delivery. Chlorine is unloaded from road tankers at the unloading station (left side of the diagram). Unloading takes place via a 5 m transfer hose into an 18 m transfer line. The product is stored in two pressurized vessels (centre of the diagram). Chlorine is subsequently led through a feed line to a reactor unit. (This reactor unit is not considered in the scenario.)

The entire installation from the unloading station to the reactor unit is equipped with automatic gas sensors. If chlorine is detected, a signal will be sent to the control room and an alarm will go off. Remotely operated valves that can be closed by an operator in the control room, are present at various locations in the plant. The operators in the control room have no direct view on the chlorine installation. The pre-defined conditions and inputs to the consequence analysis of the scenario are given in Tables 2-7.

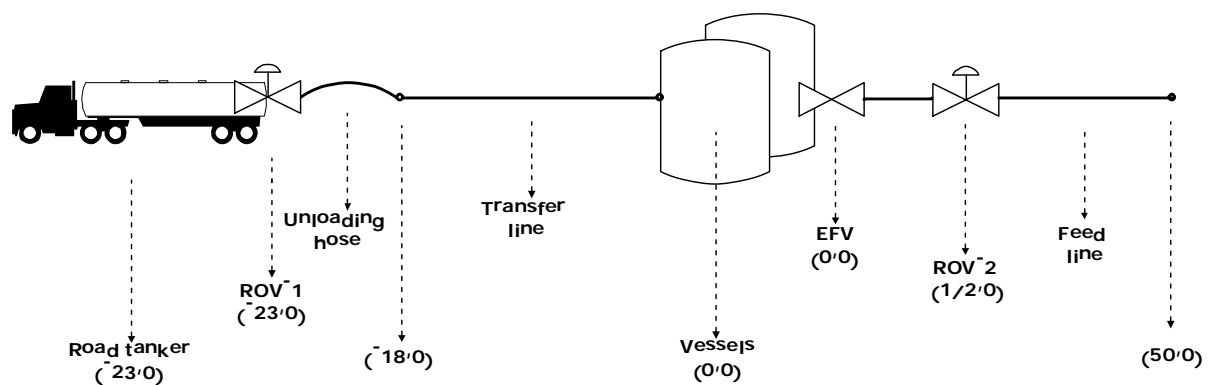

Figure 544 Illustration of fictitious chlorine facility for case study

**Table 2 The chlorine unloading process**

<b>Road tankers</b>	<ul style="list-style-type: none"> <li>• There are 150 road tanker deliveries per year.</li> <li>• It is estimated that road tankers are present at the site on average 3 hours per delivery. The duration of the actual delivery (flow) is assumed to be 2.5 hours. All deliveries take place during the daytime (8 am to 8 pm).</li> </ul>
<b>Chlorine in the road tankers</b>	<ul style="list-style-type: none"> <li>• Upon arrival, the road tankers hold 18,000 kg of chlorine.</li> <li>• The temperature of the product is 15 °C.</li> <li>• The pressure inside the road tanker is 6.87 bar (absolute).</li> </ul>
<b>Unloading hose</b>	<ul style="list-style-type: none"> <li>• The unloading hose is 5 m in length and has an internal diameter of 50 mm.</li> </ul>
<b>Transfer line</b>	<ul style="list-style-type: none"> <li>• The transfer line is 18 meters long and has an internal diameter of 50 mm.</li> <li>• The transfer line is connected to the vessel at the top.</li> <li>• The transfer line is only used during offloading operations.</li> <li>• The transfer line is outside, 1 m above the ground.</li> </ul>
<b>Unloading process</b>	<ul style="list-style-type: none"> <li>• Unloading takes place via a 5 m long hose that is attached to a 50 mm internal diameter single flanged joint on the road tanker.</li> <li>• The mean flow is 2 kg/s.</li> <li>• The road tanker is equipped with an internal pump with flow control. In case of an incident, the flow rate from the tanker will be limited by this pump to a maximum of 3 kg/s.</li> <li>• The road tanker is fitted with a remotely operated valve (ROV). The ROV is operated from the control room.</li> <li>• If the ROV closes, the outflow from the road tanker will stop. There will still be a backflow of vapour through a 50 mm internal diameter pipe fitted to the top of the vessel. This backflow will last until a manual valve at the vessel is closed (assumed 20 minutes). There will also be a release of about 50 kg chlorine from the hose and transfer line.</li> <li>• If the unloading hose ruptures or leaks, and the ROV at the road tanker closes, the outflow from the road tanker will stop. There will still be a backflow of vapour through the 50 mm internal diameter pipe fitted to the top of the vessel. This backflow will last until a manual valve at the vessel is closed (assumed 20 minutes). The 50 kg of 2-phase chlorine in the hose and transfer line will also be released.</li> <li>• If the transfer line ruptures or leaks, and the ROV at the road tanker closes, the outflow from the road tanker will stop. There will still be a backflow of vapour through the 50 mm internal diameter pipe fitted to the top of the vessel. This backflow will last until a manual valve at the vessel is closed (assumed 20 minutes). The 50 kg of 2-phase chlorine in the hose and transfer line will also be released.</li> <li>• There is no diked area around the unloading station.</li> <li>• No vapour return is used for the unloading activities.</li> </ul>

**Table 3 Chlorine storage vessels**

<b>Storage vessels</b>	<ul style="list-style-type: none"> <li>• Two identical pressurised vessels are used for storage. For reasons of simplicity, the vessels are assumed to be at the same location.</li> <li>• There is no bund around the vessels.</li> <li>• There is an excess flow valve (EFV) at the outlet of the vessels. This outlet is located 1 m above the ground. The EFV closes if the flow exceeds 3 kg/s. One minute is required to close the valve.</li> <li>• A remotely operated valve (ROV) is installed after a 50 cm long piece of in-between piping.</li> </ul>
<b>Chlorine in the storage vessels</b>	<ul style="list-style-type: none"> <li>• The maximum amount of chlorine in a vessel is 80,000 kg. Most of the time, one of the vessels is fully filled and the other vessel is partly filled. The average amount of chlorine in each of the vessels is 60,000 kg.</li> <li>• The temperature in the vessels is 15 °C. The product is 2-phase. Therefore, the pressure in the tank is 5.87 bar (absolute).</li> </ul>
<b>Feed line from storage to the reactor unit</b>	<ul style="list-style-type: none"> <li>• There is a 50 m long feed line between the ROV and the reactor unit. This feed line has 6 flanges.</li> <li>• The internal diameter is 25 mm.</li> <li>• The feed line is outside, 1 m above ground.</li> </ul>
<b>Process – storage to reactor unit</b>	<ul style="list-style-type: none"> <li>• The reactor unit uses chlorine during 10% of the time. During production, the average flow rate from the vessel to the reactor unit is 1 kg/s. During the remaining 90% of the time, flow from the vessel is blocked by a valve.</li> <li>• If the feed line ruptures or leaks, the outflow from the vessel will stop if the EFV or the ROV at the outlet of the vessel closes. There will be no backflow from the plant. The amount of chlorine in the feed line is about 35 kg.</li> </ul>
<b>The process plant</b>	<ul style="list-style-type: none"> <li>• The plant itself is not considered. The chlorine is consumed directly. No chlorine will be released due to plant processes in case of an incident.</li> </ul>

**Table 4 Site control and management systems**

<b>The control system of the chlorine Facility</b>	<ul style="list-style-type: none"> <li>• Chlorine will be delivered when one of the storage tanks is almost empty. The chlorine vessels are equipped with a standard level control and the levels can be read by operators in the control room. A warning will be issued in the operator room when a control detects a level of 90%.</li> </ul>
<b>Safety system of the chlorine facility</b>	<ul style="list-style-type: none"> <li>• A written procedure exists for the unloading activities. Prior to the start of the unloading activity operators in the control room will determine which storage tank will be filled. Part of this procedure is that operators need to check the level of both storage tanks prior to unloading.</li> <li>• The chlorine plant is equipped with gas detection and remotely operated safety valves.</li> <li>• The detection of chlorine is automatic and is designed to be sufficiently sensitive for both leaks and ruptures. Upon detection, the sensors will transmit a signal to the control room. In the control room, the operator must validate the signal and close the right valve with a switch.</li> <li>• The probabilities that the remotely operated valves will not close (due to failing detection, operator error or failing valves) are unknown. Default values need to be used. Default values also need to be used for the time required for the gas detection, operator action and subsequent closing of the valve.</li> </ul>



**Table 5 General conditions of the site**

<b>Meteorological data</b>	<ul style="list-style-type: none"> <li>The following meteorological classes are used: <ul style="list-style-type: none"> <li>- Neutral weather (Pasquill class D), wind speed 2.4 m/s (D 2.4)</li> <li>- Neutral weather (Pasquill class D), wind speed 4.3 m/s (D 4.3)</li> <li>- Neutral weather (Pasquill class D), wind speed 6.7 m/s (D 6.7)</li> <li>- Stable weather (Pasquill class F), wind speed 2.4 m/s (F 2.4)</li> </ul> </li> <li>Neutral weather (Pasquill class D) may occur both day and night. Stable weather (Pasquill class F) occurs almost exclusively during the night.</li> <li>The average temperatures of the atmosphere and the substrate are 15 °C (both day and night).</li> </ul>
<b>Wind direction</b>	<ul style="list-style-type: none"> <li>The distribution (in 12 sectors) of the wind direction per weather class is given in <b>Table 6</b>.</li> <li>A surface roughness length of 300 mm is appropriate for all wind directions.</li> </ul>
<b>Surroundings of the chlorine facility</b>	<ul style="list-style-type: none"> <li>The terrain of the plant is square, 200×200 m and centered around the origin.</li> <li>Table 19 gives an overview of the relevant population objects in the vicinity of the chlorine site. The same data are shown on a map in Figure 9.</li> <li>There are no airports in the vicinity of the plant.</li> <li>During the day, 90% of the persons are indoors, while 10% are outside. During the night, 99% of the persons are indoors, while 1% are outside.</li> <li>The ventilation rate for all population objects is 2 air changes per hour.</li> <li>The distribution of land uses around the plant is given in <b>Table 7</b>.</li> </ul>

**Table 6 Distribution of meteorological classes and wind direction sectors**

	345-15	15-45	45-75	75-105	105-135	135-165	165-195	195-225	225-255	255-285	285-315	315-345
<b>D 2.4</b>	0.0132	0.0200	0.0192	0.0139	0.0115	0.0098	0.0114	0.0136	0.0116	0.0082	0.0081	0.0096
<b>D 4.3</b>	0.0230	0.0378	0.0344	0.0212	0.0155	0.0134	0.0179	0.0203	0.0146	0.0092	0.0097	0.0132
<b>D 6.7</b>	0.0554	0.0878	0.0704	0.0352	0.0219	0.0223	0.0362	0.0431	0.0275	0.0139	0.0136	0.0226
<b>F 2.4</b>	0.0130	0.0275	0.0308	0.0223	0.0160	0.0104	0.0114	0.0121	0.0081	0.0053	0.0057	0.0074

**Note:** The wind direction equals the direction towards which the wind is blowing.

**Table 7 Population objects (land use) around the chlorine plant**

Code	Object	X-coordinate	Y-coordinate	Population
A	School	0	1000	100
A	Group of three houses	0	1000	9
B	Group of three houses	0	900	9
C	Group of three houses	0	800	9
C	Office building	0	-800	150
D	Group of three houses	0	700	9
E	Group of three houses	0	600	9
F	Group of three houses	0	500	9
G	Group of three houses	0	400	9
H	Group of three houses	0	300	9
I	Group of three houses	0	200	9
I	Office building	0	-200	150

## 8.2 The LPG depot case study

Figure 55 gives an overview of the configuration of the LPG depot. Propane and butane are unloaded from rail tankers in the unloading station (left side of the diagram). Unloading takes place via 5 m long transfer arms into 18 m long transfer lines. Propane is stored in two cylindrical vessels in a mound. Butane is stored in a separate pressurised spherical vessel. Product can subsequently be transferred to a road tanker loading station, from where it will leave the depot. Specific schemes for the unloading and loading activities are shown in Figures 56-57-58.

The entire depot is equipped with a fully automatic gas detection and blocking system (hereafter called the 'safety system'). If flammable gasses are detected at the depot, a signal will be sent to the control room, an alarm will go off and all automatic valves will close. The safety system can also be triggered by various manual push-buttons around the loading and unloading stations and by sudden pressure drops in the storage tanks and other triggers. The pre-defined conditions and inputs to the consequence analysis of the scenario are given in Tables 8-11. The general conditions for the LPG depot case study are the same as for the chlorine facility case study (Tables 5-7).

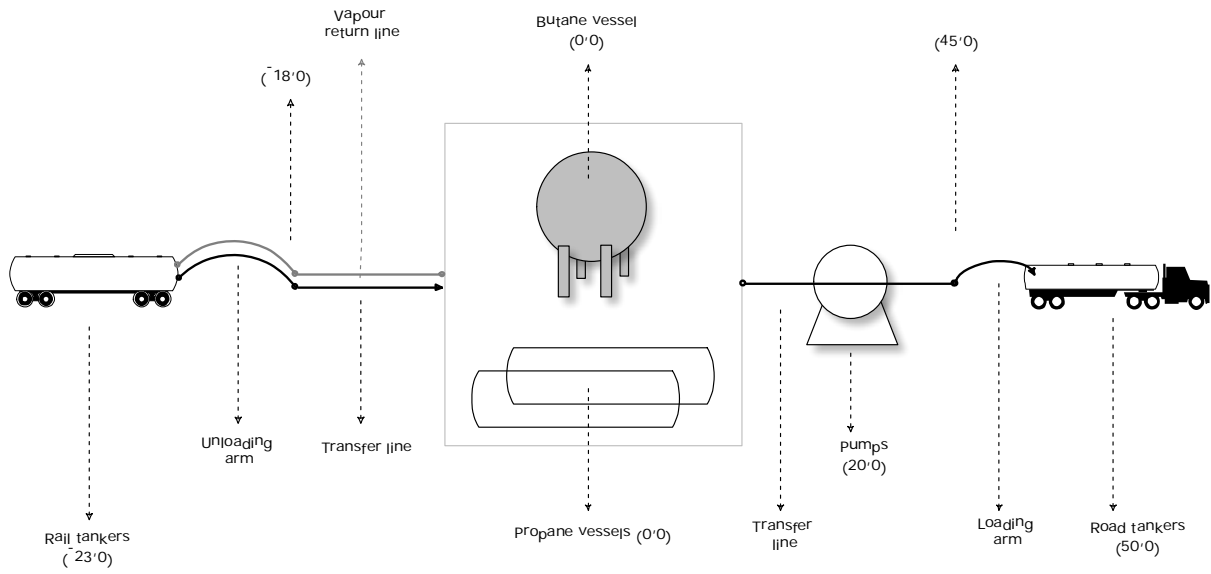

Figure 55 Overview of the LPG depot

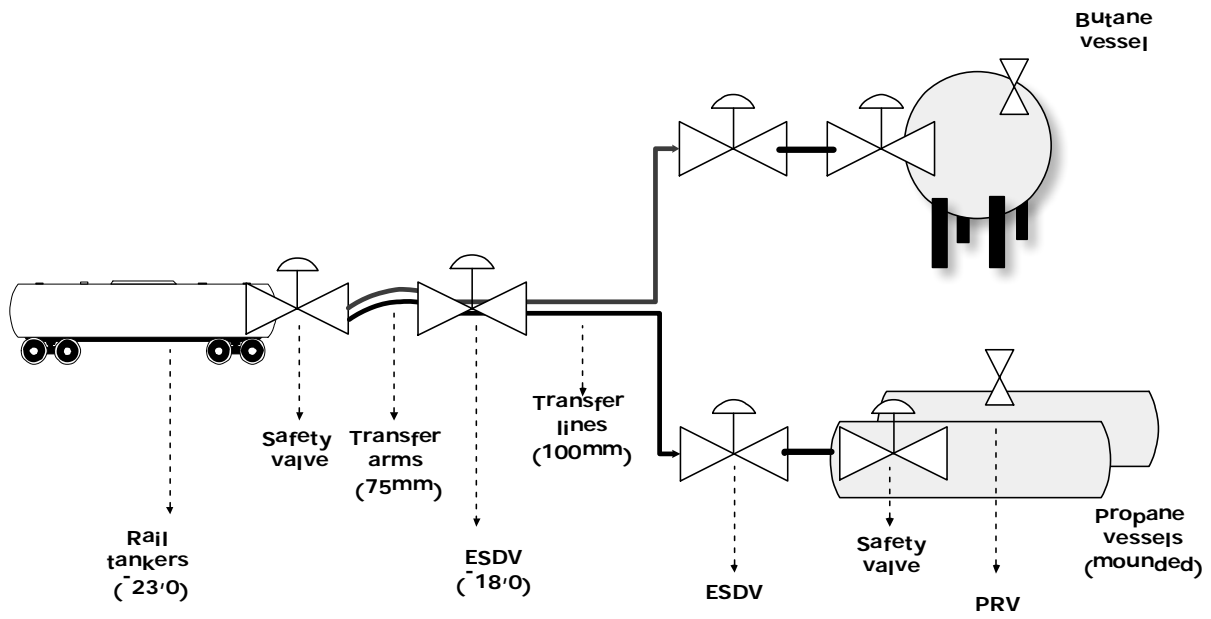

Figure 56 Unloading of propane or butane: liquid lines

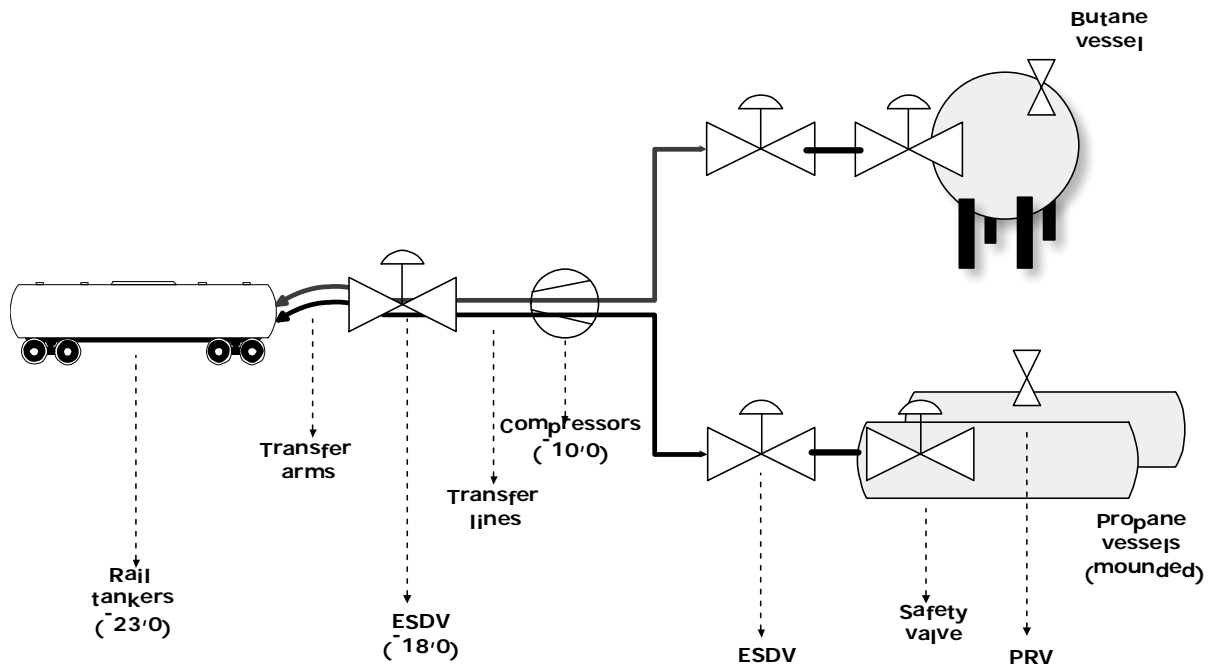

Figure 57 Unloading of propane or butane: vapour return lines

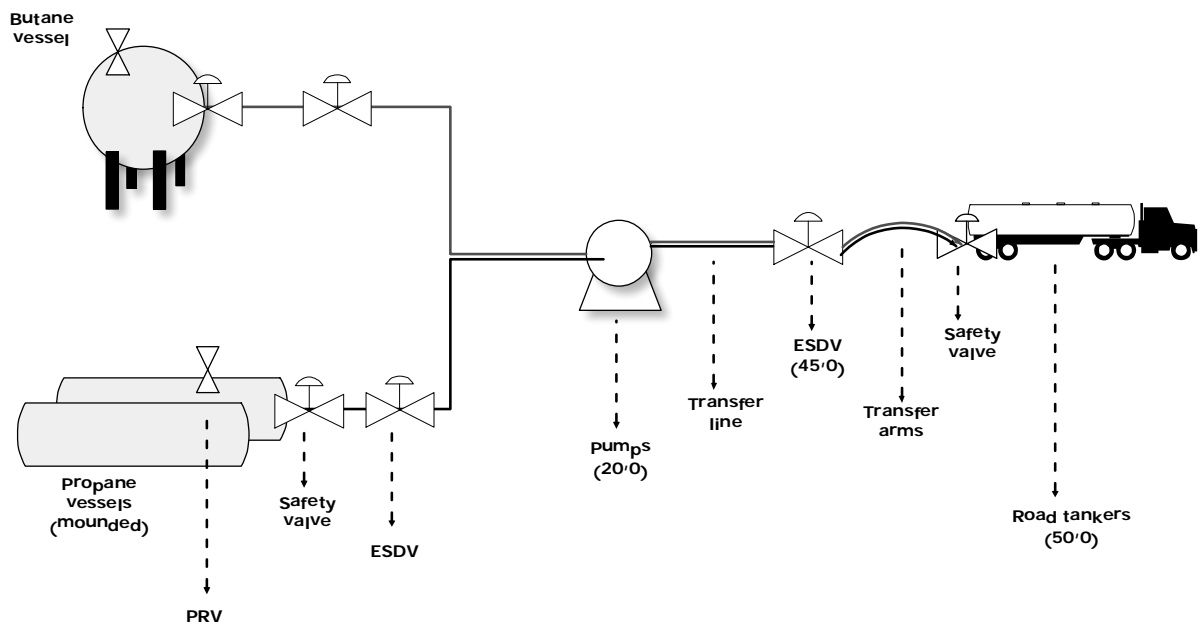

Figure 58 Loading of LPG

**Table 8 The LPG unloading process**

<p><b>The unloading station (rail tankers)</b></p>	<ul style="list-style-type: none"> <li>• The unloading station has two delivery points, one for propane and one for butane.</li> <li>• There are 1000 deliveries per year, 900 deliveries of propane and 100 deliveries of butane.</li> </ul>
<p><b>Process of unloading propane</b></p>	<ul style="list-style-type: none"> <li>• The capacity of the propane rail tankers is 119 m<sup>3</sup>. The maximum volume of propane in the tankers is 101 m<sup>3</sup> (85%).</li> <li>• The temperature in the tanker car is 20 °C and the pressure is 9,36 bar (absolute).</li> <li>• The flow rate for unloading is 100 m<sup>3</sup>/hr (14.07 kg/s).</li> <li>• The rail tanker has an internal excess flow valve (EFV), that limits the discharge from the rail tanker to a maximum of 25 kg/s.</li> <li>• The total duration of each transfer is 1 hour and the total duration of the stay at the unloading station is 1 hour and twenty minutes.</li> </ul>
<p><b>Process of unloading butane</b></p>	<ul style="list-style-type: none"> <li>• The capacity of the butane rail tankers is 94 m<sup>3</sup>. The maximum volume of butane in the tankers is 80 m<sup>3</sup> (85%).</li> <li>• The butane is 100% n-butane.</li> <li>• The temperature in the tanker car is 20 °C and the pressure is 3,06 bar (absolute).</li> <li>• The flow rate for unloading is 100 m<sup>3</sup>/hr (16.25 kg/s).</li> <li>• The rail tanker has an internal EFV, that limits the discharge from the rail tanker to a maximum of 30 kg/s.</li> <li>• The total duration of each transfer is fifty minutes and the total duration of the stay at the unloading station is 1 hour and ten minutes.</li> </ul>
<p><b>Propane and butane rail tankers</b></p>	<p>Both are equipped with:</p> <ul style="list-style-type: none"> <li>• An internal safety valve on the liquid outlet that will close when the breakaway coupling breaks and when activated by the safety system.</li> <li>• Manual valves on the vapour and liquid outlets.</li> <li>• A 75 mm internal diameter liquid outlet.</li> <li>• A 75 mm internal diameter vapour inlet</li> <li>• A breakaway coupling that detects displacement of the tankers</li> </ul>
<p><b>Unloading station and unloading arms</b></p>	<ul style="list-style-type: none"> <li>• The unloading stations are equipped with one unloading arm each.</li> <li>• The unloading arms are 5 m in length and consist of a 75 mm internal diameter vapour line and a 75 mm internal diameter liquid line.</li> <li>• The unloading arms are equipped with an emergency shut down valve (ESDV) near the transfer line. These valves can be activated by the safety system.</li> </ul>
<p><b>Transfer lines for unloading</b></p>	<ul style="list-style-type: none"> <li>• Two liquid transfer lines (one for propane and one for butane) lead from the unloading station to the storage vessels. The transfer lines are 18 meters long.</li> <li>• Two vapour return lines (one for propane and one for butane) go from the storage vessels to centrifugal compressors, located 10 meters left of the vessels. These compressors have a maximum capacity of 160 m<sup>3</sup> per hour. Further vapour lines leads from the compressors to the unloading station.</li> <li>• All transfer lines have an internal diameter of 100 mm (DN100).</li> <li>• All transfer lines are connected to the vessels at the top.</li> <li>• All transfer lines are only used during offloading operations.</li> <li>• All transfer lines are located 1 m above the ground.</li> </ul>

**Table 9 The LPG storage vessels**

<b>Storage vessels</b>	<ul style="list-style-type: none"> <li>• Two cylindrical pressurised vessels are used for the storage of propane.</li> <li>• One outdoor spherical vessel is used for storage of butane.</li> <li>• For reasons of simplicity, all three vessels are assumed to be at the same location (0,0).</li> </ul>
<b>Propane storage vessels</b>	<ul style="list-style-type: none"> <li>• These vessels have a capacity of 2500 m<sup>3</sup> each and are placed inside a mound (1 m soil cover). The diameter of the vessels is 7.2 m and the length 64 m.</li> <li>• The maximum filling ratio is 0.85, average filling ratio is 0.60 and minimum filling 0.07.</li> <li>• The temperature in the vessels is 20 °C. The product is 2-phase. Therefore, the pressure in the tanks is 8.36 bar (absolute).</li> <li>• Two pressure relief valves (PRV) are fitted to the top of the tank. The pressure setting of the PRV is 15.5 bar (absolute). The vent stack is located 10 m above ground, has an internal diameter of 150 mm (DN150) and will release vertically.</li> </ul>
<b>Butane storage vessel</b>	<ul style="list-style-type: none"> <li>• This vessel has a capacity of 700 m<sup>3</sup>.</li> <li>• The maximum filling ratio is 0.55, average filling is 0.35 and minimum filling 0.07.</li> <li>• The vessel is located in a concrete basin of 8 m X 8 m X 1.5 m.</li> <li>• The temperature in the vessels is 20 °C. The product is 2-phase. Therefore, the pressure in the tanks is 2.06 bar (absolute).</li> <li>• Two pressure relief valves (PRV) are fitted to the top of the tank. The pressure setting of the PRV is 9.7 bar (absolute). The vent stack is located 10 m above ground, has an internal diameter of 150 mm (DN150) and will release vertically.</li> </ul>
<b>Inlet/outlet lines of storage vessels</b>	<p>The propane and butane storage vessels are equipped with the following inlet/outlet lines:</p> <ul style="list-style-type: none"> <li>• One liquid inlet line (fitted to the top of the tank).</li> <li>• One liquid outlet line (fitted to the bottom of the tank).</li> <li>• One vapour return line (fitted to the top of the tank).</li> <li>• One purging line (nitrogen) (fitted to the top of the tank).</li> </ul>
<b>Storage vessel metering</b>	<p>The propane and butane storage vessels are equipped with the following metering:</p> <ul style="list-style-type: none"> <li>• A level gauging system in the tank, connected to the control system and the safety system.</li> <li>• A flow meter in the liquid outlet line, connected to the control system and the safety system.</li> <li>• Pressure and temperature meters in the outlet lines, connected to the control system and safety system</li> </ul>
<b>Storage vessel valves</b>	<p>The propane and butane storage vessels are equipped with the following types of valves:</p> <ul style="list-style-type: none"> <li>• All vapour and liquid inlet and outlet lines are equipped with an internal safety shut-off valve. This valve can be activated by the control system and the safety system and by heat from a nearby fire.</li> <li>• All vapour and liquid inlet and outlet lines are equipped with an external emergency shutdown valve (ESDV) that can be activated by the control system and the safety system.</li> <li>• All vapour and liquid inlet and outlet lines are equipped with additional manual valves.</li> <li>• Each storage tank has two pressure relief valves (PRV) connected to a vent stack at 10 m height (effective diameter of PRV 150 mm).</li> </ul>

**Table 10 The LPG loading process**

<b>Loading station for road tankers</b>	<ul style="list-style-type: none"> <li>• The loading station has two transfer points for the loading of LPG road tankers (see Fig.21)</li> <li>• There are 2000 transhipments of LPG per year.</li> </ul>
<b>Transfer lines for loading</b>	<ul style="list-style-type: none"> <li>• Two liquid transfer lines (one for propane and one for butane) lead from the storage vessels to a pump (length 20 m) and then on to the loading station (length 30 m). There are no vapour return lines for the loading activity.</li> <li>• The pumps are located 20 m left of the vessels.</li> <li>• The propane pump has a maximum capacity of 150 m<sup>3</sup> per hour and a maximum head of 22 bar.</li> <li>• The butane pump has a maximum capacity of 60 m<sup>3</sup> per hour and a maximum head of 7 bar.</li> <li>• Both pumps are centrifugal pumps.</li> <li>• All transfer lines have an internal diameter of 100 mm (DN100).</li> <li>• All transfer lines are only used during loading operations.</li> <li>• All transfer lines are located 1 m above the ground.</li> </ul>
<b>Loading arms</b>	<ul style="list-style-type: none"> <li>• The loading station has two filling points and two loading arms. Both loading arms are 5 m in length and have an internal diameter of 100 mm.</li> <li>• Each loading arm is equipped with an emergency shutdown valve (ESDV) close to the transfer line. These valves can be activated by the safety system.</li> </ul>
<b>Road tankers</b>	<ul style="list-style-type: none"> <li>• All LPG road tankers are equipped with:</li> <li>• A 100 mm (DN100) internal diameter liquid inlet.</li> <li>• A breakaway coupling that detects displacement of the tankers</li> <li>• An internal safety valve on the liquid inlet that will close when the breakaway coupling breaks and when activated by the safety system.</li> <li>• A manual valve on the liquid inlet.</li> </ul>
<b>LPG in road tankers</b>	<ul style="list-style-type: none"> <li>• The total capacity of the LPG road tankers is 55 m<sup>3</sup>. The maximum volume of LPG in the tankers is 50 m<sup>3</sup> (90%).</li> <li>• On the average, the LPG consists of 90 wgt% propane and 10 wgt% butane.</li> <li>• The temperature in the tanker car is 20 °C and the pressure is 8,87 bar (absolute).</li> </ul>
<b>LPG loading process</b>	<ul style="list-style-type: none"> <li>• The flow rate is 60 m<sup>3</sup>/hr (8.43 kg/s).</li> <li>• The total duration of each transfer is fifty minutes and the total duration of the stay at the loading station is 1 hour and ten minutes. Each vessel will first be filled with butane (average 10 wgt%) and then with propane (average 90 wgt%).</li> <li>• There is only transfer of liquefied propane/butane, no transfer of vapour.</li> </ul>

**Table 11 General conditions of the LPG site**

<p><b>Control system of the LPG depot</b></p>	<ul style="list-style-type: none"> <li>• The LPG depot is equipped with an automated control system. Level controls and control valves are present in all tanks and flow meters are present in all transfer lines. The control system is connected to the safety system.</li> </ul>
<p><b>Safety system of the LPG depot</b></p>	<ul style="list-style-type: none"> <li>• The safety system is fed by the control system and a number of additional independent triggers:</li> <li>• Each tank is equipped with a level alarm that is independent of the control system. The safety system will be activated when the volume in a tank reaches 90% (propane) or 60% (butane) of the total vessel volume.</li> <li>• The entire depot is equipped with a fully automatic gas detection system. Gas detection leads to full activation of the safety system.</li> <li>• Various manual push-buttons are present around the loading and unloading stations. These push buttons activate the safety system. According to the procedure, the truck driver will be present at the loading stations during the entire (un)loading process.</li> <li>• Activation of the safety system means that a signal will be sent to the control room and all safety valves (including ESDVs) connected to the safety system will close automatically.</li> <li>• The probabilities that the emergency shut-down valves will not close (due to failing detection, malfunction in automated system or failing valves) are unknown. Default values need to be used. Default values also need to be used for the time required for the gas detection, response time of automated system and closing of the valves.</li> </ul>

### 8.3 Results from the case study exercises

Table 4 provides an overview of land-use planning decisions following application of the scenario in accordance with the relevant risk assessment methodology and land-use planning decision procedure of the participating countries and regions. Figure 59 and Table 12 show the land-use planning decisions in spatial and table format. The results can be summarized as follows:

- Only one country/region (P4) would allow land-use within 300 m of the facility.
- One country/region (P8) prohibited land-use within 1000 m of the facility.
- Half of the participants would have allowed residential housing at 600 m.



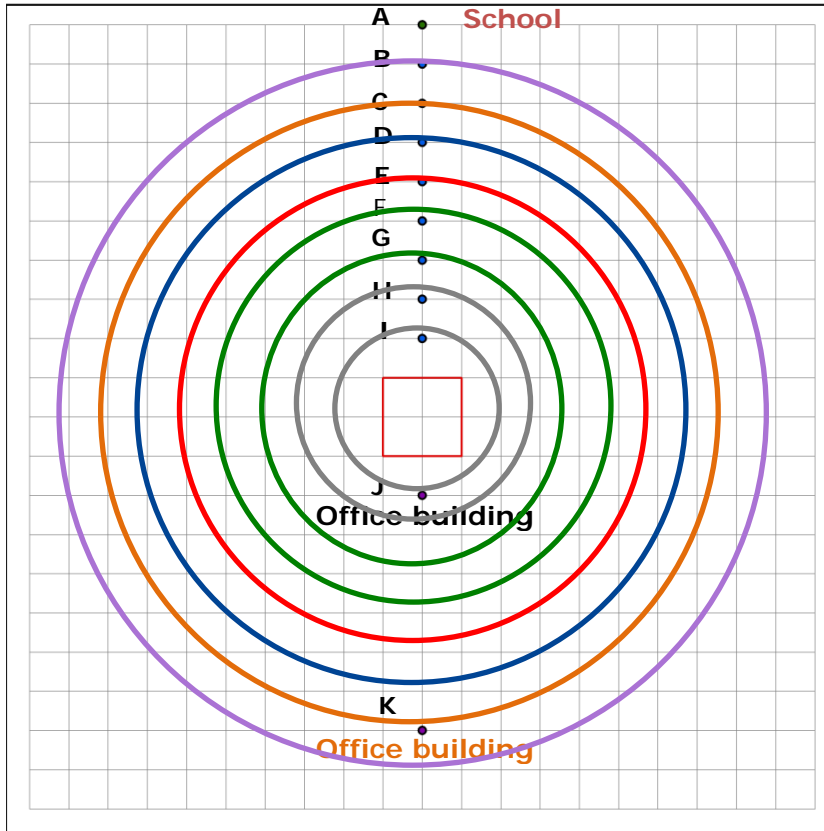

**Figure 59 Spatial perspective of land-use planning decisions from the chlorine facility analyses**

**Table 12 Land-use planning decisions based on the chlorine facility analyses**

	Distance	Development Allowed
A	School 1000 m	P1,P3,P7
A	1000 m	P1,P2,P3,P4,P5,P6,P7
B	900 m	P1,P2,P3,P4,P5,P6,P7
C	800 m	P1,P2,P3,P4,P5,P6
K	Office building 800 m	P1,P3,P4,P5
D	700 m	P1,P2,P4,P5,P6
E	600 m	P1,P2,P4,P5
F	500 m	P1,P2,P4
G	400 m	P1,P2,P4
H	300 m	P4
I	200 m	P4
J	Office building 200 m	P4

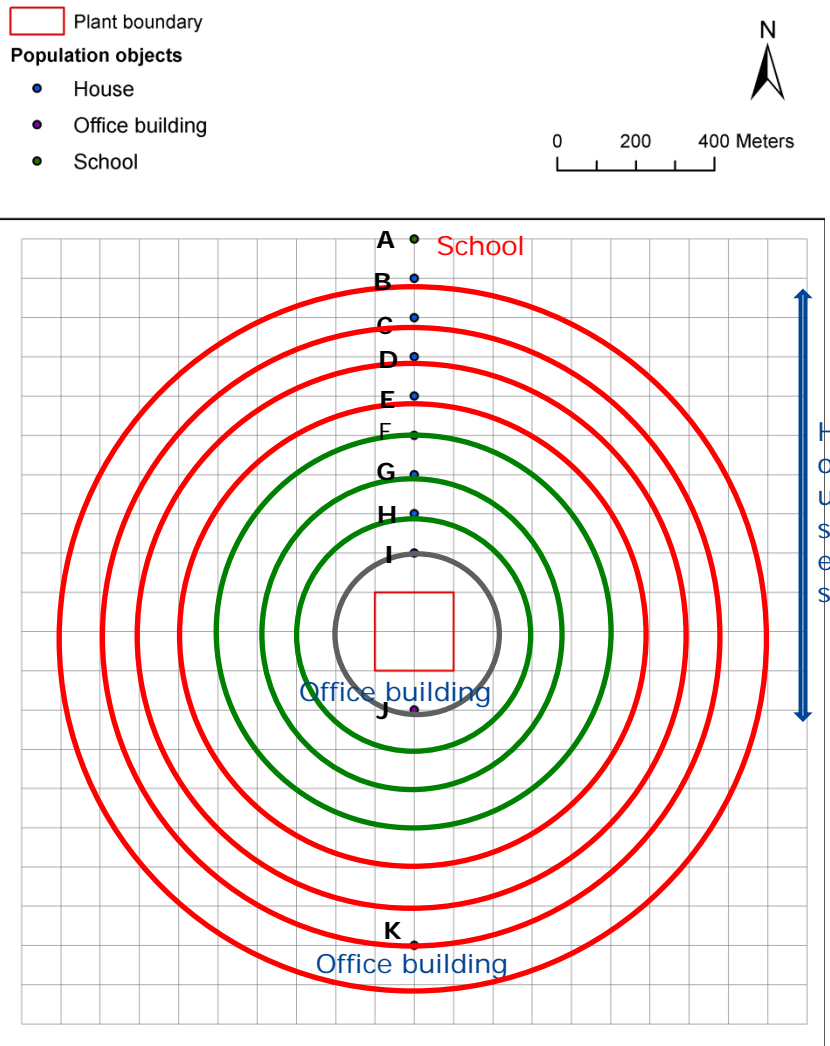

Figure 60 Spatial perspective of land-use planning decision LPG facility analyses

Table 13 Land-use planning decisions based on the LPG facility analyses

	Distance	Development Allowed
A	School 1000 m	ALL
A	1000 m	ALL
B	900 m	ALL
C	800 m	ALL
K	Office building 800 m	ALL
D	700 m	ALL
E	600 m	ALL
F	500 m	P1,P2,P4,P5,P6,P7,P8
G	400 m	P1,P2,P4,P5,P6,P7,P8
H	300 m	P1,P2,P4,P5,P6,P7,P8
I	200 m	P2,P5
J	Office building 200 m	P5,P6

- All but one country would have allowed residential housing at 900 m.
- Only 3 countries would have permitted the presence of a school at 1000 m distance.

A review of the inputs of each team showed that the loss of containment scenarios and frequencies assigned to the same or similar scenarios could vary widely across teams.

**Table 14 Examples of loss of containment (critical event) scenarios and frequencies used for pipework failure producing a toxic cloud at the chlorine facility**

Participant A		Participant B	
Critical Event	Frequency	Critical Event	Frequency
Equipment failure, partial rupture pipe leak 15mm diameter	2 E-07	Transfer line/full bore rupture	1.8 E-05
Random (corrosion, external event ...) partial rupture, pipe leak, 15mm diameter	2 E-07	Transfer line/leak	9 E-05
Flange leak (seal fault)	4 E-04	Feed line/ full bore rupture	5 E-6
Compressors flank failure	4 E-04	Feed line/leak	2.5 E-05

Distances calculated for the chlorine release also varied widely sometimes by more than a few 1000 metres, depending on the consequence assessment model used and the inputs (e.g., acute exposure threshold).

As shown in Figure 60 and Table 13, results from applying different risk assessment methods and land-use planning approaches varied only slight in regard to the LPG facility. All but 2 countries/regions prohibited development within 200 m of the plant. Conversely, 7 out of the 8 countries/regions permitted development at 300 m and beyond. At 600 m every country region allowed development.

As with the chlorine case study, LOC scenarios and associated frequencies varied considerably, except that frequencies assigned to the scenarios were generally rather low ( $< 10^{-6}$ ). Hence, variation in distance calculations did not cause a considerable variation in the land-use planning decisions of each participating team. In general, most land-uses were permitted within 300 m of the plant given the low probability that an accident could cause a fatality or injury in the area.

In both case studies, teams assessed a wide range of scenarios. The scenarios with the worst outcomes in terms of probability of death or serious injury in proximity to the plant, drove the land-use planning decisions. Also, in these cases, participants allowed a number of safety barriers to reduce the probability associated with certain dangerous phenomena, and these barriers were described in their documentation.

## 8.4 Conclusions

The outcome of the benchmarking exercise supports the use of common scenarios across European Union and affiliated countries as a way of achieving more consistency and transparency in how Member State land-use planning (and emergency planning) decisions in how land-use planning decisions are made. Even though there still remained numerous inputs that caused considerable variation in the outcomes in different locations, the assessment frameworks followed a common structure and decisions were made on the basis of calculations and logic produced within this structure.

Regardless of any other circumstances, certain dangerous substances have the potential to produce dangerous phenomena. Consistent with this principle, common reference scenarios provide a common starting point for any risk assessment associated with release of the specific substance involved. The use of scientifically-determined common reference scenarios within the European Union can be an additional assurance for living near hazardous facilities citizens that all necessary measures have been taken to protect man and the environment from chemical accidents.

**Annex 1** contains an example of the assessment of the chlorine facility case study by the United Kingdom.

**Annex 2** contains the assessment of the LPG facility case study conducted by the Netherlands.

## **9 Annex I: Assessment of the Chlorine facility LUP Case by one Member State: United Kingdom (HSE)**

### **Application of RHAD Event trees to Chlorine Case Study**

This note illustrates the application of the chlorine event trees to the chlorine case study (see description at Appendix 2) by the HSE in the UK. Where necessary, HSE standard LUP assumptions have been used to supplement the information in the event trees and case study.

### **Scenario development**

The relevant event tree was applied to each section of the hypothetical chlorine establishment.

#### **Scenario Tree 1. Road Tanker (Event tree “Scenario for chlorine tank car/wagon”)**

A road tanker is present on site for 150 x 3 hours per year. This is a presence factor of 0.05 and this will be used to factor the failure rates used.

### **Catastrophic failure**

For catastrophic failure, HSE assumes that 50% of the events eject the entire inventory into the cloud (“upward release”) which is then assumed to disperse. The remaining 50% eject half of the inventory into the cloud (“downward release”) and half into a liquid pool on the ground. The evaporation from the liquid pool is considered to add little to the overall hazard and is ignored.

The event tree includes the pressure effects of the tanker failure. In the UK, this hazard is not considered to contribute significantly to the offsite risks and is ignored.

### **Road tanker hole dimensions**

HSE uses a set of standard hole sizes for chlorine pressure vessels (50mm, 25mm, 13mm and 6mm) with associated failure frequencies. The holes are apportioned between the liquid and vapour space and internal HSE guidance suggests that the ratio in this case is 50:50. Consequently, half of the holes are in lower part of the tanker and release liquid for the entire duration of the release and half are in the upper part of the tanker and release vapour.

The flow rates are determined using the HSE code STREAM. The duration of release is 30 minutes or the time to release half of the tanker contents (i.e. 9000 kg).

### **Failure of tanker offloading pipe (pre-ROSOV)**

There is either a short section of pipe from the tanker to the first remotely operated shut-off valve (termed ROSOV in the UK or ROV in the case study at Appendix 2) or there is the chance that the ROSOV may be struck from the tanker (passing vehicle, etc.). It is assumed in the case study description that the internal tanker pump will limit the flow from the tanker to 3 kg/s.

The chlorine is transferred through a connection in the vessel vapour space. At the time of failure, there will be vapour backflow from the storage vessel (1.9 kg/s based on STREAM (5.87 bara pressure and 23m of 50mm pipe)). The forward flow is assumed to last for 30 minutes with the back flow limited to 20 minutes. The total combined flow is averaged over 30 minutes in the following way:

$$\text{Average flow for 30 minutes} = [(3 \times 1800) + (1.9 \times 1200)]/1800 = 4.3 \text{ kg/s}$$

The failure rate is based on the 25mm vessel hole rather than a pipe failure since failure is likely to be caused by vehicle impact, etc. rather than normal pipework failures.

### **Scenario Tree 2. Unloading Hose (Event tree "Scenario for chlorine loading/unloading")**

The offloading system is assumed to be "average" in terms of failure likelihood and there are 150 delivery operations per year. The tanker ROSOV is assumed to close in 5 minutes (i.e. time for gas detection to detect the release, the operator to react to the alarm and the closure mechanism to operate) when it works and has a failure probability of 0.03 failures per demand. Scenarios were developed for both ROSOV working (closing on demand) and failing (not closing on demand).

For relatively short lengths of pipework, it is assumed that the failure occurs half way along the hose (to give average flow conditions) and that the maximum forward flow is limited by the tanker pump to 3 kg/s. The vapour backflow is recalculated with the same source conditions as above but a shorter length of pipework (i.e. 18m of transfer line plus 2.5m of loading hose). The recalculated backflow is 2.0 kg/s.

HSE assumes a standard set of failures (guillotine failure, 15mm hole and 5mm hole). STREAM was set to give 3 kg/s through the guillotine failure (pump limited) and the flows for the holes determined accordingly. For the holes, it is assumed that the backflow would be prevented by the forward flow or not contribute significantly to the hazard.

The combined flow for the guillotine failures is averaged over 20 minutes when the ROSOV works (i.e. the back flow duration) and 30 minutes when it fails, using the same logic as in 2.1 above. For the holes, the durations are 5 minutes (ROSOV works) and 30 minutes (ROSOV fails).

### **Scenario Tree 3. Transfer Line (Event tree “Scenario for chlorine loading/unloading”)**

As in Scenario Tree 2, the tanker ROSOV is assumed to close in 5 minutes when it works and has a failure probability of 0.03 failures per demand. Again, scenarios were developed for both ROSOV working and failing.

It is assumed that the failure occurs half way along the transfer line (9m from the vessel) to give average flow conditions and that the maximum forward flow is limited by the tanker pump to 3 kg/s. The vapour backflow is recalculated as 2.6 kg/s.

HSE assumes a standard set of failures (guillotine failure, 25mm hole and 3mm hole). STREAM was set to give 3 kg/s through the guillotine failure (pump limited) and the flows for the holes determined accordingly. For the holes, it is assumed that the backflow would be prevented by the forward flow or not contribute significantly to the hazard.

Again, the combined flow for the guillotine failures is averaged over 20 minutes when the ROSOV works (i.e. the back flow duration) and 30 minutes when it fails. For the holes, the durations are 5 minutes (ROSOV works) and 30 minutes (ROSOV fails).

### **Scenario Tree 4. Storage Vessels (Event tree “Scenario for chlorine storage tank”)**

It is assumed that there are 2 vessels each with an inventory of 60,000 kg. This is a simplifying assumption since the actual inventory in each vessel will cycle between 80,000 kg and a minimum, pre-filling inventory (say 10,000 kg).

#### **Catastrophic Failure**

For catastrophic failure, HSE assumes that 50% of the events eject the entire inventory into the cloud (“upward release”) with the remaining 50% (“downward release”) ejecting half of the inventory into the cloud and half into a liquid pool on the ground. The evaporation from the liquid pool is considered to add little to the overall hazard and is ignored.

#### **Vessel hole dimensions**

HSE has a set of standard hole sizes for chlorine pressure vessels (50mm, 25mm, 13mm and 6mm) with associated failure frequencies. The holes are apportioned between the liquid and vapour space and internal HSE guidance suggests that the ratio in this case is 50:50 since the vessels are not banded. Consequently, half of the holes are in lower part of the vessel and release liquid for the entire duration of the release and half are in the upper part of the vessel and release vapour.

The flow rates are determined using the HSE code STREAM. The duration of release is 30 minutes or the time to release half of the tanker contents (i.e. 30,000 kg).

### **Failure of feed line (pre-ROSOV)**

There is a short section of pipe from the vessel to the second ROSOV. It is assumed in the case study description that the vessel excess flow valve (termed XSFV in the UK or EFV in the case study at Appendix 2) will limit the flow from the vessel to 3 kg/s. Scenarios were developed for both XSFV working (1 minute flow of 3 kg/s) and failing to restrict the flow (giving 4.8 kg/s for 30 minutes).

The failure rate is based on guillotine failure of 0.5m of 25mm diameter pipe.

### **Scenario Tree 5. Feed Line (Event tree “Scenario for chlorine pipework”)**

In the case study description, it is assumed that the feed line is only in use 10% of the time.

### **Pipework Failure**

It is assumed that the failure occurs half way along the transfer line (25m from the vessel) to give average flow conditions and that the maximum forward flow is limited by the vessel XSFV to 3 kg/s when it works.

HSE assumes a standard set of failures (guillotine failure, 25mm hole and 3mm hole). STREAM was used to determine the flow through the guillotine failure in the absence of restriction (i.e. no XSFV) and this was found to be 2.3 kg/s. Consequently, the XSFV would have no impact on the assessment in this simplified case (i.e. single failure at 25m). The flows for the holes were determined using the pipe split model in STREAM.

The vessel ROSOV is assumed to close in 5 minutes when it works (i.e. shuts off the flow) and has a failure probability of 0.03 failures per demand. Scenarios were developed for both ROSOV working (closing on demand) and failing (not closing on demand).

From the case study description, there is no backflow from the reactor.

### **Flange Failure**

The feed line has 6 flanges. HSE has standard failure rates for flanges and assumes that the failure is represented by the ejection of the gasket between 2 bolts. For a 25mm line with “4 bolt” flanges this is  $\frac{1}{4}$  of the circumference and (assuming a 3.2mm thick gasket) gives a flow area equivalent to an 8mm hole.

Again, scenarios were developed for both ROSOV working and failing.



## Risk Assessment

### Individual Risk

Individual risks around the hypothetical site were determined using the scenarios in Table 1 and the HSE risk assessment tool RISKAT. Two assessments were carried out; one for the tanker offloading where the probability of F2.4 weather was set to 0 (daytime only operation) and one for the vessel and feed line releases using the full weather set (24 hour operations). The risk contours (10, 1 and 0.3 cpm of Dangerous Dose) from the 2 assessments were combined and the overall risk is given in Figure 1a.

A number of scenarios in Table 1 were excluded from the risk assessment on the grounds of low frequency. These are indicated in the last column of Table 1 by a "Y".

From Figure 1a, it can be seen that the following zone limits can be determined for this hypothetical plant:

Inner Zone	= 310m max.
Middle Zone	= 800m max.
Outer Zone/CD	= 1570m max.

### Societal Risk

Societal risks were determined using the internal HSE model QuickFN which is based on work carried out for HSE by ERM (see research report RR283 on HSE's website). All the events in Table 1 were included in the assessment.

QuickFN is limited to 2 weather conditions; D5 and F2. HSE has data files for such weather (.w2 files) but they are derived differently to the weather used in the individual risk assessment (termed .WEA files). For this assessment, the W2 directional probabilities were used with the F2 probability set to 0 for offloading events (D5 set to 1 - F2, i.e.  $1 - 0.17 = 0.83$ ).

The results are presented at Figure 1b. As tanker offloading was assumed to take place during the day, 2 separate FN curves were produced to cover:

- offloading operations (F2 probability set to 0); and
- normal activities.

It can be seen that the combined FN curve lies mostly within the lower part of the HSE "Tolerable if ALARP" region.

## **Conclusions**

The generic RHAD event trees have been applied to the hypothetical chlorine site and a set of 43 scenarios generated. This included events where the ROSOVs and XSFV worked or failed.

The most significant events (based on frequency) were used to generate individual risk contours using the HSE model RISKAT. These contours are of a typical size for such major hazards facilities.

The events were also used to generate societal risk FN curves using the HSE model QuickFN. These show societal risks which are relatively low but this is a reflection of the absence of major population centres around the hypothetical site.

**Table 15 Case Study Scenarios**

Event	Flow	Duration	Base frequency	Multipliers	Event frequency	Comments	Excluded from RA
2.1 Road Tanker Events							
Tanker catastrophic failure	18000 kg	Inst.	2.00E-06	0.5 x 0.05	5.00E-08	50% upwards with 100% into cloud, present for 150 x 3 hours per year, pressure effects ignored	Y
Tanker catastrophic failure	9000 kg	Inst.	2.00E-06	0.5 x 0.05	5.00E-08	50% downwards with 50% into cloud, present for 150 x 3 hours per year, pressure effects ignored	Y
Tanker 50mm hole (liquid)	26.4 kg/s	5.7 min	5.00E-06	0.5 x 0.05	1.25E-07	50% holes in liquid space, present for 150 x 3 hours per year	
Tanker 25mm hole (liquid)	6.2 kg/s	24.2 min	5.00E-06	0.5 x 0.05	1.25E-07	50% holes in liquid space, present for 150 x 3 hours per year	
Tanker 13mm hole (liquid)	1.6 kg/s	30 min	1.00E-05	0.5 x 0.05	2.50E-07	50% holes in liquid space, present for 150 x 3 hours per year	
Tanker 6mm hole (liquid)	0.25 kg/s	30 min	4.00E-05	0.5 x 0.05	1.00E-06	50% holes in liquid space, present for 150 x 3 hours per year	
Tanker 50mm hole (vapour)	4.4 kg/s	30 min	5.00E-06	0.5 x 0.05	1.25E-07	50% holes in vapour space, present for 150 x 3 hours per year	
Tanker 25mm hole (vapour)	1.1 kg/s	30 min	5.00E-06	0.5 x 0.05	1.25E-07	50% holes in vapour space, present for 150 x 3 hours per year	
Tanker 13mm hole (vapour)	0.3 kg/s	30 min	1.00E-05	0.5 x 0.05	2.50E-07	50% holes in vapour space, present for 150 x 3 hours per year	
Tanker 6mm hole (vapour)	0.06 kg/s	30 min	4.00E-05	0.5 x 0.05	1.00E-06	50% holes in vapour space, present for 150 x 3 hours per year	
Tanker offloading pipe failure (pre ROSOV)	4.3 kg/s	30 min	5.00E-06	0.05	2.50E-07	Guillotine failure plus vapour backflow from tank, frequency based on 25mm tank hole and tanker presence	

2.2 Unloading Hose							
Loading hose guillotine failure (ROSOV works)	2.8 kg/s	20 min	4.00E-06	150 x 0.97	5.82E-04	Combined flow averaged over 20 min, 150 deliveries	
Loading hose guillotine failure (ROSOV fails)	4.3 kg/s	30 min	4.00E-06	150 x 0.03	1.80E-05	Combined flow averaged over 30 min, 150 deliveries	
Loading hose 15mm hole (ROSOV works)	1.06 kg/s	5 min	4.00E-07	150 x 0.97	5.82E-05	Forward flow only for 5 min, 150 deliveries	
Loading hose 15mm hole (ROSOV fails)	1.06 kg/s	30 min	4.00E-07	150 x 0.03	1.80E-06	Forward flow only for 30 min, 150 deliveries	
Loading hose 5mm hole (ROSOV works)	0.2 kg/s	5 min	6.00E-06	150 x 0.97	8.73E-04	Forward flow only for 5 min, 150 deliveries	
Loading hose 5mm hole (ROSOV fails)	0.2 kg/s	30 min	6.00E-06	150 x 0.03	2.70E-05	Forward flow only for 30 min, 150 deliveries	
2.3 Transfer Line							
Transfer line guillotine failure (ROSOV works)	3.2 kg/s	20 min	5.00E-07	18 x 0.97 x 0.05	4.37E-07	Combined flow averaged over 20 min, present for 150 x 3 hours per year	
Transfer line guillotine failure (ROSOV fails)	4.0 kg/s	30 min	5.00E-07	18 x 0.03 x 0.05	1.35E-08	Combined flow averaged over 30 min, present for 150 x 3 hours per year	Y
Transfer line 25mm hole (ROSOV works)	2.3 kg/s	5 min	1.00E-06	18 x 0.97 x 0.05	8.73E-07	Forward flow only for 5 min, present for 150 x 3 hours per year	
Transfer line 25mm hole (ROSOV fails)	2.3 kg/s	30 min	1.00E-06	18 x 0.03 x 0.05	2.70E-08	Forward flow only for 30 min, present for 150 x 3 hours per year	Y
Transfer line 3mm hole (ROSOV works)	0.06 kg/s	5 min	2.00E-06	18 x 0.97 x 0.05	1.75E-06	Forward flow only for 5 min, present for 150 x 3 hours per year	
Transfer line 3mm hole (ROSOV fails)	0.06 kg/s	30 min	2.00E-06	18 x 0.03 x 0.05	5.40E-08	Forward flow only for 30 min, present for 150 x 3 hours per year	Y
2.4 Storage Vessels							

Vessel catastrophic failure	60000 kg	Inst.	2.00E-06	2 x 0.5	2.00E-06	50% upwards with 100% into cloud
Vessel catastrophic failure	30000 kg	Inst.	2.00E-06	2 x 0.5	2.00E-06	50% downwards with 50% into cloud
Vessel 50mm hole (liquid)	20.3 kg/s	24.6 min	5.00E-06	2 x 0.5	5.00E-06	50% holes in liquid space
Vessel 25mm hole (liquid)	4.8 kg/s	30 min	5.00E-06	2 x 0.5	5.00E-06	50% holes in liquid space
Vessel 13mm hole (liquid)	1.2 kg/s	30 min	1.00E-05	2 x 0.5	1.00E-05	50% holes in liquid space
Vessel 6mm hole (liquid)	0.24 kg/s	30 min	4.00E-05	2 x 0.5	4.00E-05	50% holes in liquid space
Vessel 50mm hole (vapour)	3.8 kg/s	30 min	5.00E-06	2 x 0.5	5.00E-06	50% holes in vapour space
Vessel 25mm hole (vapour)	0.94 kg/s	30 min	5.00E-06	2 x 0.5	5.00E-06	50% holes in vapour space
Vessel 13mm hole (vapour)	0.25 kg/s	30 min	1.00E-05	2 x 0.5	1.00E-05	50% holes in vapour space
Vessel 6mm hole (vapour)	0.05 kg/s	30 min	4.00E-05	2 x 0.5	4.00E-05	50% holes in vapour space
Outlet pipe fails (XSFV works)	3 kg/s	1 min	1.00E-06	2 x 0.5 x 0.987	9.87E-07	XSFV limits flow to 3 kg/s, 0.5m length of pipe
Outlet pipe fails (XSFV fails)	4.8 kg/s	30 min	1.00E-06	2 x 0.5 x 0.013	1.30E-08	Flow equivalent to 25 mm hole in vessel, 0.5m length of pipe
<b>2.5 Feed Line</b>						
Feed line Guillotine failure (ROSOV works)	2.3 kg/s	5 min	1.00E-06	50 x 0.97 x 0.1	4.85E-06	50m line, only used 10% of time
Feed line Guillotine failure (ROSOV fails)	2.3 kg/s	30 min	1.00E-06	50 x 0.03 x 0.1	1.50E-07	50m line, only used 10% of time
Feed line 25mm hole (XSFV works, ROSOV works)	1.8 kg/s	5 min	5.00E-06	50 x 0.97 x 0.1	2.43E-05	50m line, only used 10% of time
Feed line 25mm hole (XSFV works, ROSOV fails)	1.8 kg/s	30 min	5.00E-06	50 x 0.03 x 0.1	7.50E-07	50m line, only used 10% of time
Feed line 3mm hole (XSFV works, ROSOV works)	0.06 kg/s	5 min	1.00E-05	50 x 0.97 x 0.1	4.85E-05	50m line, only used 10% of time

Feed line 3mm hole (XSFV works, ROSOV fails)	0.06 kg/s	30 min	1.00E-05	50 x 0.03 x 0.1	1.50E-06	50m line, only used 10% of time	
Feed line flange leak (ROSOV works)	0.3 kg/s	5 min	5.00E-06	6 x 0.97 x 0.1	2.91E-06	6 flanges, only used 10% of time	
Feed line flange leak (ROSOV fails)	0.3 kg/s	30 min	5.00E-06	6 x 0.03 x 0.1	9.00E-08	6 flanges, only used 10% of time	Y

Figure Case Study Individual Risk Contours

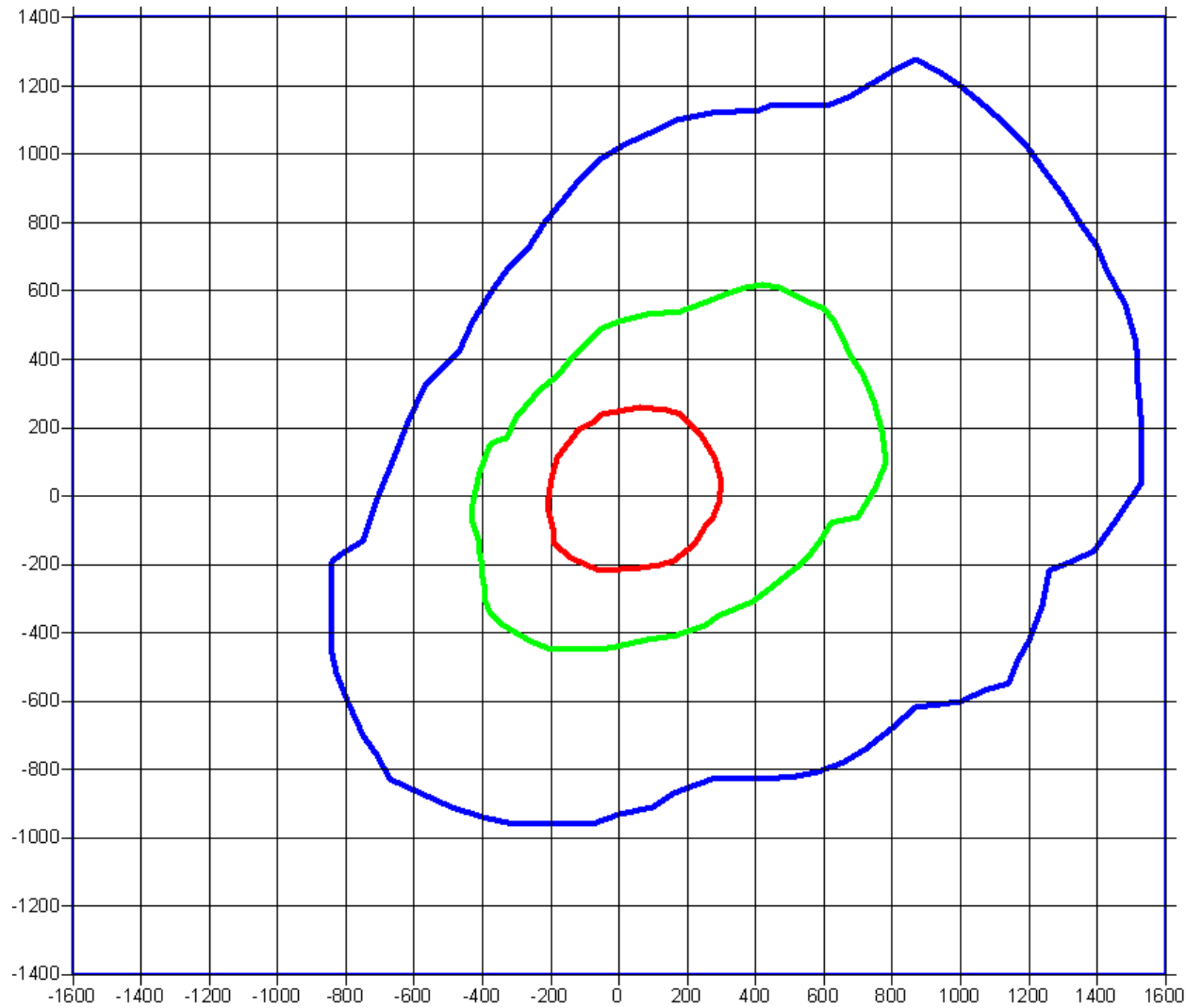

RHAD Chlorine Case Study

Release point at (0, 0)  
Contours are 10, 1 and  
0.3 cpm Dangerous Dose

Figure Case Study Societal Risk FN Curves

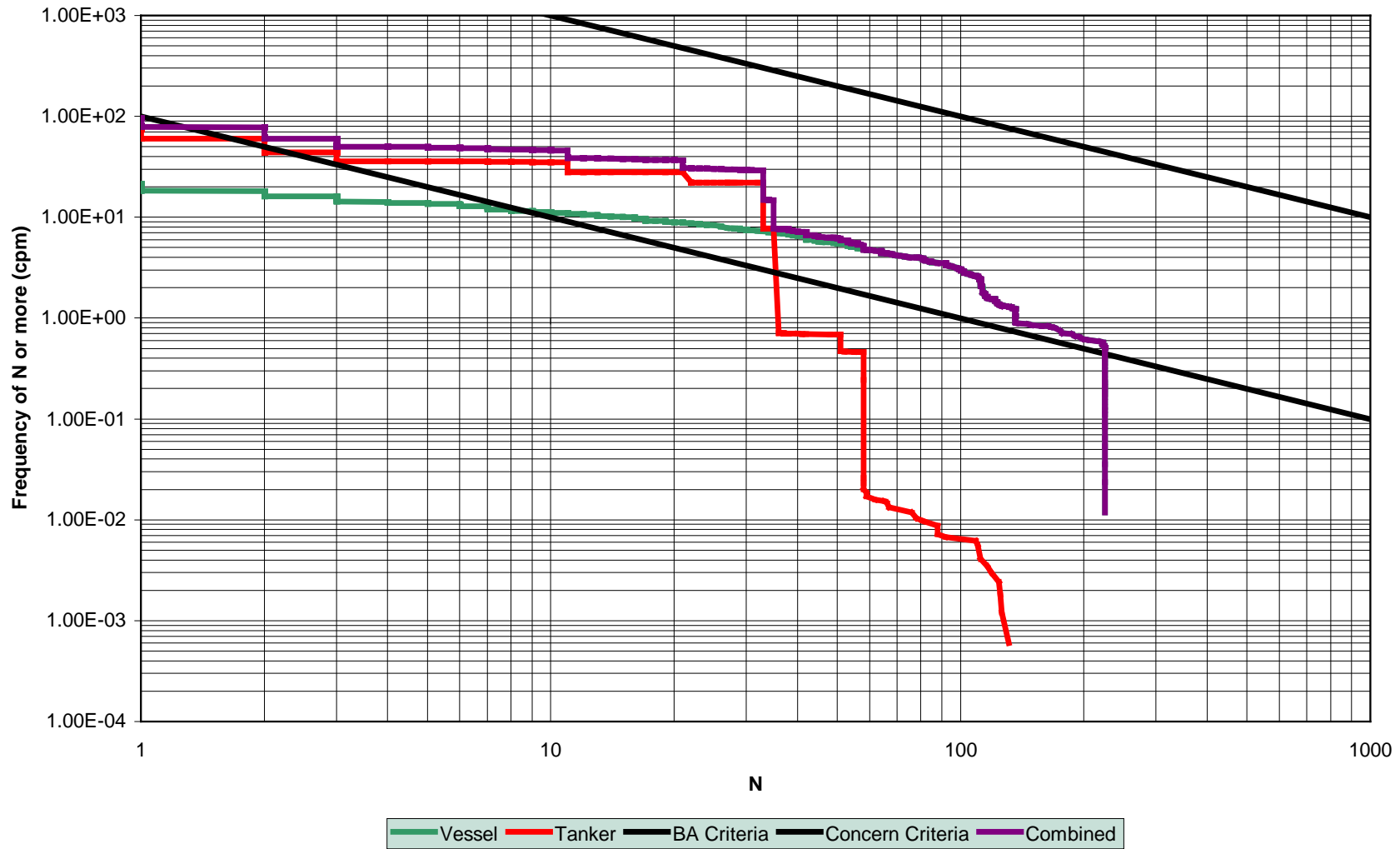



## Annex II: Assessment of the LPG Depot LUP case by one Member State: The Netherlands (RIVM)

### Part I: Describing the initiating event(s)

In this section describe all of the possible initiating events that you consider in your analysis.

1. Describe the initiating event(s) that lead to the Critical Event(s) In Dutch QRA generic frequencies are used for all critical events. Generally, when deriving generic frequencies, all relevant causes are taken into account.
--

2. Specify the involved equipments and/or instruments and provide a short description of the possible causes that initiated the events		
Equipment	Component	Causes (e.g. corrosion, erosion, human failure, etc)
rail tanker		Generic
unloading arm		Generic
transfer line		Generic
storage vessel		Generic
loading arm		Generic
road tanker		Generic

3. Please add notes if you deem necessary to do so.

## Part II: Identifying all possible failures

### Pressurised Storage Tank

In this section describe all of the possible failures for the pressurised storage tank in your analysis.

4. Describe the failures for the pressurised storage tank			
Equipment	Type of failure	Failure frequency	Source
Pressurised storage tank	Catastrophic failure - instantaneous release	5E-7 y-1	Reference Manual Bevi Risk Assessments, version 3.2, RIVM, 1 July 2009
	Catastrophic failure -release in 10 minutes	5E-7 y-1	Reference Manual Bevi Risk Assessments, version 3.2, RIVM, 1 July 2009
	10 mm hole	1E-5 y-1	Reference Manual Bevi Risk Assessments, version 3.2, RIVM, 1 July 2009

5. Please add notes if you deem necessary to do so.

## Pipework

In this section describe all of the possible failures for the pipework in your analysis.

6. Describe the failures for the pipework			
Equipment	Type of failure	Failure frequency	Source
Pipework	Full bore rupture	1E-6 m-1y-1 (diameter <75 mm); 3E-7 m-1y-1 (75 mm < diameter < 150 mm); 1E-7 m-1y-1 (diameter >150 mm)	Reference Manual Bevi Risk Assessments, version 3.2, RIVM, 1 July 2009
	Leak with an effective diameter of 10% of the nominal diameter, up to a maximum of 50 mm	5E-6 m-1y-1 (diameter < 75 mm); 2E-6 m-1y-1 (75 mm < diameter < 150 mm); 5E-7 m-1y-1 (diameter > 150 mm)	Reference Manual Bevi Risk Assessments, version 3.2, RIVM, 1 July 2009

7. Please add notes if you deem necessary to do so.
Frequencies mentioned are valid for an aboveground pipeline in process setting.

## Loading/unloading hose

In this section describe all of the possible failures for the loading/unloading hose in your analysis.

8. Describe the failures for the loading/unloading hose			
Equipment	Type of failure	Failure frequency	Source
Loading/unloading hose	Full bore rupture	4E-6 hr-1	Reference Manual Bevi Risk Assessments, version 3.2, RIVM, 1 July 2009

	Leak	4E-5 hr-1	Reference Manual Bevi Risk Assessments, version 3.2, RIVM, 1 July 2009
--	------	-----------	---

9. Please add notes if you deem necessary to do so

--

### Tankcar/wagon

In this section describe all of the possible failures for the tankcar/wagon in your analysis.

10. Describe the failures for the Tankcar/wagon			
Equipment	Type of failure	Failure frequency	Source
Tankcar/wagon	Catastrophic failure - instantaneous release	5E-7 y-1	Reference Manual Bevi Risk Assessments, version 3.2, RIVM, 1 July 2009
	Release of entire contents from the largest connection	5E-7 y-1	Reference Manual Bevi Risk Assessments, version 3.2, RIVM, 1 July 2009

11. Please add notes if you deem necessary to do so.

Frequencies mentioned are valid for a road tanker with a pressurised tank.

**Additional equipment**

In this section describe all of the possible failures for the additional equipments that are addressed in your analysis.

12. Describe the failures for the given additional equipment(s)			
Equipment	Type of failure	Failure frequency	Source
pump (canned, without gasket)	Catastrophic failure	1E-5 y-1	Reference Manual Bevi Risk Assessments, version 3.2, RIVM, 1 July 2009
	Leak (10 % diameter)	5E-5 y-1	Reference Manual Bevi Risk Assessments, version 3.2, RIVM, 1 July 2009
ESDV	ESDV does not close	1E-3 per operation	Reference Manual Bevi Risk Assessments, version 3.2, RIVM, 1 July 2009

13. Please add notes if you deem necessary to do so.

### Part III: Identifying all possible critical events (CE)

#### Pressurised storage tank

In this section describe the possible Critical Events that are addressed in your analysis.

14. Describe the Critical Event(s)	
Equipment	Critical Event
Pressurised storage tank	Catastrophic failure - instantaneous release
	Catastrophic failure -release in 10 minutes
	leak from a 10 mm hole

15. Please add notes if you deem necessary to do so.





**Loading/unloading hose**

In this section describe the possible Critical Events that are addressed in your analysis.

18. Describe the Critical Event(s)	
Equipment	Critical Event
Loading/unloading hose	Full bore rupture
	Leak with an effective diameter of 10% of the nominal diameter

19. Please add notes if you deem necessary to do so.

**Tankcar/wagon**

In this section describe the possible Critical Events that are addressed in your analysis.

20. Describe the Critical Event(s)	
Equipment	Critical Event
Tankcar/wagon	Catastrophic failure - instantaneous release
	Release of entire contents from the largest connection

21. Please add notes if you deem necessary to do so.

### Part III: Selection of the critical event(s)

#### Pressurised Storage Tank

24. Describe the selected Critical Events for the pressurised storage tank.	
CE	CE frequency

25. Please add notes if you deem necessary to do so.

**Pipework**

26. Describe the selected Critical Events for the pipework.	
CE	CE frequency

27. Please add notes if you deem necessary to do so.

**Loading/Unloading hose**

28. Describe the selected Critical Events for the loading/unloading hose.	
CE	CE frequency

29. Please add notes if you deem necessary to do so.

**Tankcar/wagon**

30. Describe the selected Critical Events for the tankcar/wagon.	
CE	CE frequency

31. Please add notes if you deem necessary to do so.

**Additional equipment**

Insert any further equipment that you consider in your analysis and which was not listed before (please insert as many sheets as you need).

32. Describe the selected Critical Events for the additional equipments.		
Equipment	CE	CE frequency

33. Please add notes if you deem necessary to do so.

## Part IV: Describing the dangerous phenomena

### Pressurised storage tank

In this section describe all of the possible dangerous phenomena taken into consideration in relation to the Critical Event.

34. Describe the dangerous phenomena		
Critical Event	Dangerous phenomena (please insert more rows if you need)	Frequency of the dangerous pheomena
Propane   Catastrophic rupture	Flash fire	4.2E-07
Propane   Catastrophic rupture	Explosion	2.8E-07
Propane   Catastrophic rupture	Flash fire	1.8E-07
Propane   Catastrophic rupture	Vapour cloud explosion	1.2E-07
Propane   Ten minute release	Jet Fire	7.0E-07
Propane   Ten minute release	Flash fire	1.8E-07
Propane   Ten minute release	Vapour cloud explosion	1.2E-07
Propane   10 mm leak	Jet Fire	4.0E-06
Propane   10 mm leak	Flash fire	9.6E-06
Propane   10 mm leak	Vapour cloud explosion	6.4E-06
Propane   Pressure relief valve	Jet Fire	2.0E-05
Propane   Pressure relief valve	Flash fire	1.2E-05
Propane   Pressure relief valve	Vapour cloud explosion	8.0E-06
Butane   Catastrophic rupture	Flash fire	2.1E-07
Butane   Catastrophic rupture	Explosion	1.4E-07
Butane   Catastrophic rupture	Flash fire	9.0E-08
Butane   Catastrophic rupture	Vapour cloud explosion	6.0E-08
Butane   Ten minute release	Jet Fire	3.5E-07
Butane   Ten minute release	Flash fire	9.0E-08
Butane   Ten minute release	Vapour cloud explosion	6.0E-08
Butane   10 mm leak	Jet Fire	2.0E-06

Butane   10 mm leak	Flash fire	4.8E-06
Butane   10 mm leak	Vapour cloud explosion	3.2E-06
Butane   Pressure relief valve	Jet Fire	1.0E-05
Butane   Pressure relief valve	Flash fire	6.0E-06
Butane   Pressure relief valve	Vapour cloud explosion	4.0E-06
35. Please add notes if you deem necessary to do so		



## Pipework

In this section describe all of the possible dangerous phenomena taken into consideration in relation to the Critical Event.

36. Describe the dangerous phenomena		
Critical Event	Dangerous phenomena (please insert more rows if you need)	Frequency of the dangerous phenomena
Transfer line		
Propane   Rupture of the transfer line   both ESDVs close	Jet Fire	9.1E-07
Propane   Rupture of the transfer line   both ESDVs close	Flash fire	5.4E-07
Propane   Rupture of the transfer line   both ESDVs close	Vapour cloud explosion	3.6E-07
Propane   Rupture of the transfer line   one or two ESDVs fail	Jet Fire	1.8E-08
Propane   Rupture of the transfer line   one or two ESDVs fail	Flash fire	1.1E-08
Propane   Rupture of the transfer line   one or two ESDVs fail	Vapour cloud explosion	7.4E-09
Propane   Rupture of the transfer line   safety valve fails	Jet Fire	8.1E-08
Propane   Rupture of the transfer line   safety valve fails	Flash fire	4.8E-08
Propane   Rupture of the transfer line   safety valve fails	Vapour cloud explosion	3.2E-08
Propane   Leak from the transfer line   both ESDVs close	Jet Fire	1.8E-06
Propane   Leak from the transfer line   both ESDVs close	Flash fire	4.4E-06
Propane   Leak from the transfer line   both ESDVs close	Vapour cloud explosion	2.9E-06
Propane   Leak from the transfer line   one or two ESDVs fail	Jet Fire	3.7E-08
Propane   Leak from the transfer line   one or two ESDVs fail	Flash fire	8.8E-08
Propane   Leak from the transfer line   one or two ESDVs fail	Vapour cloud explosion	5.9E-08
Butane   Rupture of the transfer line   both ESDVs close	Jet Fire	8.4E-08
Butane   Rupture of the transfer line   both ESDVs close	Flash fire	5.0E-08
Butane   Rupture of the transfer line   both ESDVs close	Vapour cloud explosion	3.4E-08
Butane   Rupture of the transfer line   one or two ESDVs fail	Jet Fire	1.7E-09

Butane   Rupture of the transfer line   one or two ESDVs fail	Flash fire	1.0E-09
Butane   Rupture of the transfer line   one or two ESDVs fail	Vapour cloud explosion	6.8E-10
Butane   Rupture of the transfer line   safety valve fails	Jet Fire	8.9E-08
Butane   Rupture of the transfer line   safety valve fails	Flash fire	5.3E-08
Butane   Rupture of the transfer line   safety valve fails	Vapour cloud explosion	3.6E-08
Butane   Leak from the transfer line   both ESDVs close	Jet Fire	1.7E-07
Butane   Leak from the transfer line   both ESDVs close	Flash fire	4.0E-07
Butane   Leak from the transfer line   both ESDVs close	Vapour cloud explosion	2.7E-07
Butane   Leak from the transfer line   one or two ESDVs fail	Jet Fire	3.4E-09
Butane   Leak from the transfer line   one or two ESDVs fail	Flash fire	8.2E-09
Butane   Leak from the transfer line   one or two ESDVs fail	Vapour cloud explosion	5.5E-09

### Vapour return line

Propane   Rupture of the vapour return line   ESDV closes	Jet Fire	4.6E-07
Propane   Rupture of the vapour return line   ESDV closes	Flash fire	2.8E-07
Propane   Rupture of the vapour return line   ESDV closes	Vapour cloud explosion	1.9E-07
Propane   Rupture of the vapour return line   ESDV fails	Jet Fire	4.6E-10
Propane   Rupture of the vapour return line   ESDV fails	Flash fire	2.8E-10
Propane   Rupture of the vapour return line   ESDV fails	Vapour cloud explosion	1.9E-10
Propane   Leak from the vapour return line   ESDV closes	Jet Fire	1.2E-06
Propane   Leak from the vapour return line   ESDV closes	Flash fire	3.0E-06
Propane   Leak from the vapour return line   ESDV closes	Vapour cloud explosion	2.0E-06
Propane   Leak from the vapour return line   ESDV fails	Jet Fire	1.2E-09
Propane   Leak from the vapour return line   ESDV fails	Flash fire	3.0E-09
Propane   Leak from the vapour return line   ESDV fails	Vapour cloud explosion	2.0E-09

Butane   Rupture of the vapour return line   ESDV closes	Jet Fire	4.5E-08
Butane   Rupture of the vapour return line   ESDV closes	Flash fire	2.7E-08
Butane   Rupture of the vapour return line   ESDV closes	Vapour cloud explosion	1.8E-08
Butane   Rupture of the vapour return line   ESDV fails	Jet Fire	4.5E-11
Butane   Rupture of the vapour return line   ESDV fails	Flash fire	2.7E-11
Butane   Rupture of the vapour return line   ESDV fails	Vapour cloud explosion	1.8E-11
Butane   Leak from the vapour return line   ESDV closes	Jet Fire	1.2E-07
Butane   Leak from the vapour return line   ESDV closes	Flash fire	2.9E-07
Butane   Leak from the vapour return line   ESDV closes	Vapour cloud explosion	1.9E-07
Butane   Leak from the vapour return line   ESDV fails	Jet Fire	1.2E-10
Butane   Leak from the vapour return line   ESDV fails	Flash fire	2.9E-10
Butane   Leak from the vapour return line   ESDV fails	Vapour cloud explosion	1.9E-10

### Feed line (before pump)

Propane   Rupture of the transfer line   ESDV closes	Jet Fire	1.3E-06
Propane   Rupture of the transfer line   ESDV closes	Flash fire	8.0E-07
Propane   Rupture of the transfer line   ESDV closes	Vapour cloud explosion	5.4E-07
Propane   Rupture of the transfer line   ESDV fails	Jet Fire	1.3E-09
Propane   Rupture of the transfer line   ESDV fails	Flash fire	8.1E-10
Propane   Rupture of the transfer line   ESDV fails	Vapour cloud explosion	5.4E-10
Propane   Leak from the transfer line   ESDV closes	Jet Fire	3.0E-06
Propane   Leak from the transfer line   ESDV closes	Flash fire	7.2E-06
Propane   Leak from the transfer line   ESDV closes	Vapour cloud explosion	4.8E-06
Propane   Leak from the transfer line   ESDV fails	Jet Fire	3.0E-09
Propane   Leak from the transfer line   ESDV fails	Flash fire	7.3E-09
Propane   Leak from the transfer line   ESDV fails	Vapour cloud explosion	4.8E-09

Butane   Rupture of the transfer line   ESDV closes	Jet Fire	1.5E-07
Butane   Rupture of the transfer line   ESDV closes	Flash fire	8.9E-08
Butane   Rupture of the transfer line   ESDV closes	Vapour cloud explosion	6.0E-08
Butane   Rupture of the transfer line   ESDV fails	Jet Fire	1.5E-10
Butane   Rupture of the transfer line   ESDV fails	Flash fire	9.0E-11
Butane   Rupture of the transfer line   ESDV fails	Vapour cloud explosion	6.0E-11
Butane   Leak from the transfer line   ESDV closes	Jet Fire	3.4E-07
Butane   Leak from the transfer line   ESDV closes	Flash fire	8.0E-07
Butane   Leak from the transfer line   ESDV closes	Vapour cloud explosion	5.4E-07
Butane   Leak from the transfer line   ESDV fails	Jet Fire	3.4E-10
Butane   Leak from the transfer line   ESDV fails	Flash fire	8.1E-10
Butane   Leak from the transfer line   ESDV fails	Vapour cloud explosion	5.4E-10

#### Feed line (after pump)

Propane   Rupture of the transfer line   ESDV closes	Jet Fire	7.5E-07
Propane   Rupture of the transfer line   ESDV closes	Flash fire	4.5E-07
Propane   Rupture of the transfer line   ESDV closes	Vapour cloud explosion	3.0E-07
Propane   Rupture of the transfer line   ESDV fails	Jet Fire	7.6E-10
Propane   Rupture of the transfer line   ESDV fails	Flash fire	4.5E-10
Propane   Rupture of the transfer line   ESDV fails	Vapour cloud explosion	3.0E-10
Propane   Leak from the transfer line   ESDV closes	Jet Fire	2.0E-06
Propane   Leak from the transfer line   ESDV closes	Flash fire	4.8E-06
Propane   Leak from the transfer line   ESDV closes	Vapour cloud explosion	3.2E-06
Propane   Leak from the transfer line   ESDV fails	Jet Fire	2.0E-09
Propane   Leak from the transfer line   ESDV fails	Flash fire	4.8E-09
Propane   Leak from the transfer line   ESDV fails	Vapour cloud explosion	3.2E-09
Butane   Rupture of the transfer line   ESDV closes	Jet Fire	8.4E-08
Butane   Rupture of the transfer line   ESDV closes	Flash fire	5.0E-08
Butane   Rupture of the transfer line   ESDV closes	Vapour cloud explosion	3.4E-08
Butane   Rupture of the transfer line   ESDV fails	Jet Fire	8.4E-11

Butane   Rupture of the transfer line   ESDV fails	Flash fire	5.0E-11
Butane   Rupture of the transfer line   ESDV fails	Vapour cloud explosion	3.4E-11
Butane   Leak from the transfer line   ESDV closes	Jet Fire	2.2E-07
Butane   Leak from the transfer line   ESDV closes	Flash fire	5.4E-07
Butane   Leak from the transfer line   ESDV closes	Vapour cloud explosion	3.6E-07
Butane   Leak from the transfer line   ESDV fails	Jet Fire	2.2E-10
Butane   Leak from the transfer line   ESDV fails	Flash fire	5.4E-10
Butane   Leak from the transfer line   ESDV fails	Vapour cloud explosion	3.6E-10

37. Please add notes if you deem necessary to do so

--

## Loading/Unloading Hose

In this section describe all of the possible dangerous phenomena taken into consideration in relation to the Critical Event.

38. Describe the dangerous phenomena		
Critical event	Dangerous phenomena (please insert more rows if you need)	Frequency of the dangerous phenomena
Unloading arm		
Propane   Rupture of the unloading arm   both ESDVs close	Jet Fire	1.8E-05
Propane   Rupture of the unloading arm   both ESDVs close	Flash fire	1.1E-05
Propane   Rupture of the unloading arm   both ESDVs close	Vapour cloud explosion	7.1E-06
Propane   Rupture of the unloading arm   ESDV fails	Jet Fire	3.6E-07
Propane   Rupture of the unloading arm   ESDV fails	Flash fire	2.1E-07
Propane   Rupture of the unloading arm   ESDV fails	Vapour cloud explosion	1.4E-07
Propane   Leak from the unloading arm   both ESDVs close	Jet Fire	7.1E-05
Propane   Leak from the unloading arm   both ESDVs close	Flash fire	1.7E-04
Propane   Leak from the unloading arm   both ESDVs close	Vapour cloud explosion	1.1E-04
Propane   Leak from the unloading arm   one or two ESDVs fail	Jet Fire	1.4E-06
Propane   Leak from the unloading arm   one or two ESDVs fail	Flash fire	3.4E-06
Propane   Leak from the unloading arm   one or two ESDVs fail	Vapour cloud explosion	2.3E-06
Butane   Rupture of the unloading arm   both ESDVs close	Jet Fire	1.7E-06
Butane   Rupture of the unloading arm   both ESDVs close	Flash fire	1.0E-06
Butane   Rupture of the unloading arm   both ESDVs close	Vapour cloud explosion	6.9E-07
Butane   Rupture of the unloading arm   one or two ESDVs fail	Jet Fire	3.5E-08
Butane   Rupture of the unloading arm   one or two ESDVs fail	Flash fire	2.1E-08
Butane   Rupture of the unloading arm   one or two ESDVs fail	Vapour cloud explosion	1.4E-08
Butane   Leak from the unloading arm   both ESDVs close	Jet Fire	6.9E-06

Butane   Leak from the unloading arm   both ESDVs close	Flash fire	1.6E-05
Butane   Leak from the unloading arm   both ESDVs close	Vapour cloud explosion	1.1E-05
Butane   Leak from the unloading arm   one or two ESDVs fail	Jet Fire	1.4E-07
Butane   Leak from the unloading arm   one or two ESDVs fail	Flash fire	3.3E-07
Butane   Leak from the unloading arm   one or two ESDVs fail	Vapour cloud explosion	2.2E-07

### Loading arm

Propane   Rupture of the loading arm   both ESDVs close	Jet Fire	2.2E-05
Propane   Rupture of the loading arm   both ESDVs close	Flash fire	1.3E-05
Propane   Rupture of the loading arm   both ESDVs close	Vapour cloud explosion	8.8E-06
Propane   Rupture of the loading arm   ESDV fails	Jet Fire	4.5E-10
Propane   Rupture of the loading arm   ESDV fails	Flash fire	2.7E-10
Propane   Rupture of the loading arm   ESDV fails	Vapour cloud explosion	1.8E-10
Propane   Leak from the loading arm   both ESDVs close	Jet Fire	8.8E-05
Propane   Leak from the loading arm   both ESDVs close	Flash fire	2.1E-04
Propane   Leak from the loading arm   both ESDVs close	Vapour cloud explosion	1.4E-04
Propane   Leak from the loading arm   ESDV fails	Jet Fire	1.8E-09
Propane   Leak from the loading arm   ESDV fails	Flash fire	4.3E-09
Propane   Leak from the loading arm   ESDV fails	Vapour cloud explosion	2.9E-09
Butane   Rupture of the loading arm   both ESDVs close	Jet Fire	2.4E-06
Butane   Rupture of the loading arm   both ESDVs close	Flash fire	1.5E-06
Butane   Rupture of the loading arm   both ESDVs close	Vapour cloud explosion	9.8E-07
Butane   Rupture of the loading arm   ESDV fails	Jet Fire	5.0E-11
Butane   Rupture of the loading arm   ESDV fails	Flash fire	3.0E-11
Butane   Rupture of the loading arm   ESDV fails	Vapour cloud explosion	2.0E-11
Butane   Leak from the loading arm   both ESDVs close	Jet Fire	9.8E-06

Butane   Leak from the loading arm   both ESDVs close	Flash fire	2.3E-05
Butane   Leak from the loading arm   both ESDVs close	Vapour cloud explosion	1.6E-05
Butane   Leak from the loading arm   ESDV fails	Jet Fire	2.0E-10
Butane   Leak from the loading arm   ESDV fails	Flash fire	4.8E-10
Butane   Leak from the loading arm   ESDV fails	Vapour cloud explosion	3.2E-10

39. Please add notes if you deem necessary to do so



## Tankcar/Wagon

In this section describe all of the possible dangerous phenomena taken into consideration in relation to the Critical Event.

40. Describe the dangerous phenomena		
Critical event	Dangerous phenomena (please insert more rows if you need)	Frequency of the dangerous phenomena

### Rail tanker

Propane   Catastrophic rupture	Fireball	5.5E-08
Propane   Catastrophic rupture	Flash fire	8.2E-09
Propane   Catastrophic rupture	Vapour cloud explosion	5.5E-09
Propane   Release from largest connection	Jet Fire	6.8E-09
Propane   Release from largest connection	Flash fire	3.7E-08
Propane   Release from largest connection	Vapour cloud explosion	2.5E-08
Propane   Fire impingement	BLEVE	1.4E-07
Butane   Catastrophic rupture	Fireball	5.3E-09
Butane   Catastrophic rupture	Flash fire	8.0E-10
Butane   Catastrophic rupture	Vapour cloud explosion	5.3E-10
Butane   Release from largest connection	Jet Fire	6.7E-10
Butane   Release from largest connection	Flash fire	3.6E-09
Butane   Release from largest connection	Vapour cloud explosion	2.4E-09
Butane   Fire impingement	BLEVE	1.3E-08

### Road tanker

Propane   Catastrophic rupture	Fireball	5.6E-05
Propane   Catastrophic rupture	Flash fire	8.4E-06
Propane   Catastrophic rupture	Vapour cloud explosion	5.6E-06
Propane   Release from largest connection	Jet Fire	7.0E-06
Propane   Release from largest connection	Flash fire	3.8E-05
Propane   Release from largest connection	Vapour cloud explosion	2.5E-05
Propane   Fire impingement	BLEVE	1.4E-06
41. Please add notes if you deem necessary to do so		

## Part V: Impact criteria

### 1. Risk based approach

42. Provide the criteria upon which you base your decision.			
Individual risk			
Exposure time	Criteria for fatality	Criteria for injury	Probit
flammables	minimum of fire duration and 20 s	irrelevant	$Pr = -36,38 + 2,56 \ln \left( \int Q^{4/3} dt \right)$

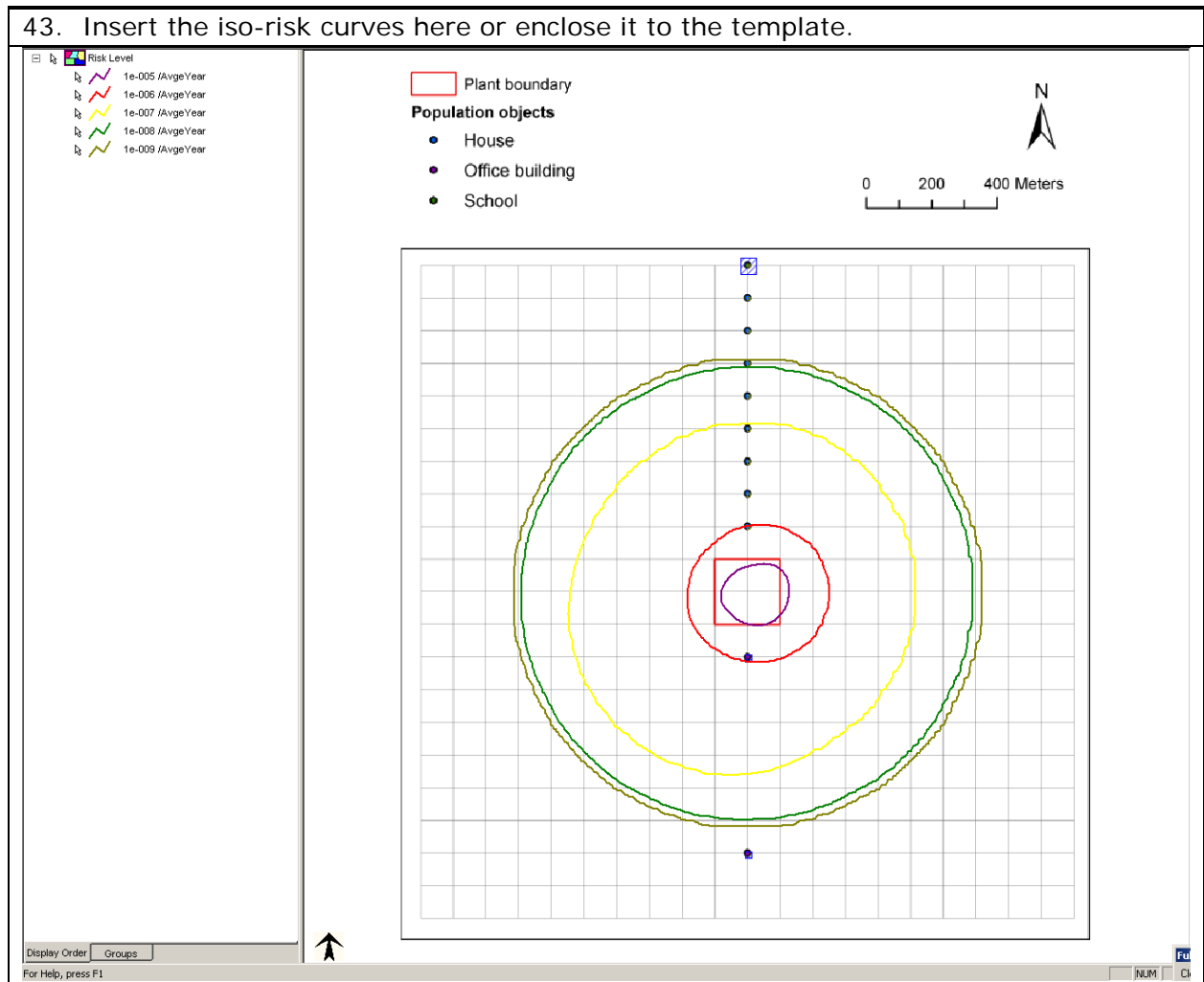

44. Describe the land use decision criteria based upon the risk contours.

No vulnerable objects are allowed within IR 10-6 contour. Vulnerable objects include dwellings (with a density of 2 per ha or more), schools, hospitals and other objects where many persons are present (sufficiently large offices, recreational and sport facilities, and so on).

The presence of objects of limited vulnerability within IR 10-6 is highly undesirable. Objects of limited vulnerability include isolated dwellings (density less than 2 per ha), neighbouring industries with similar activities, small shops, and so on.

#### 45. Societal risk

The height of the societal risk should be accounted for by the competent authority. Guidance values are defined for reference.

#### 46. Insert the F-N curve here or enclose it to the template.

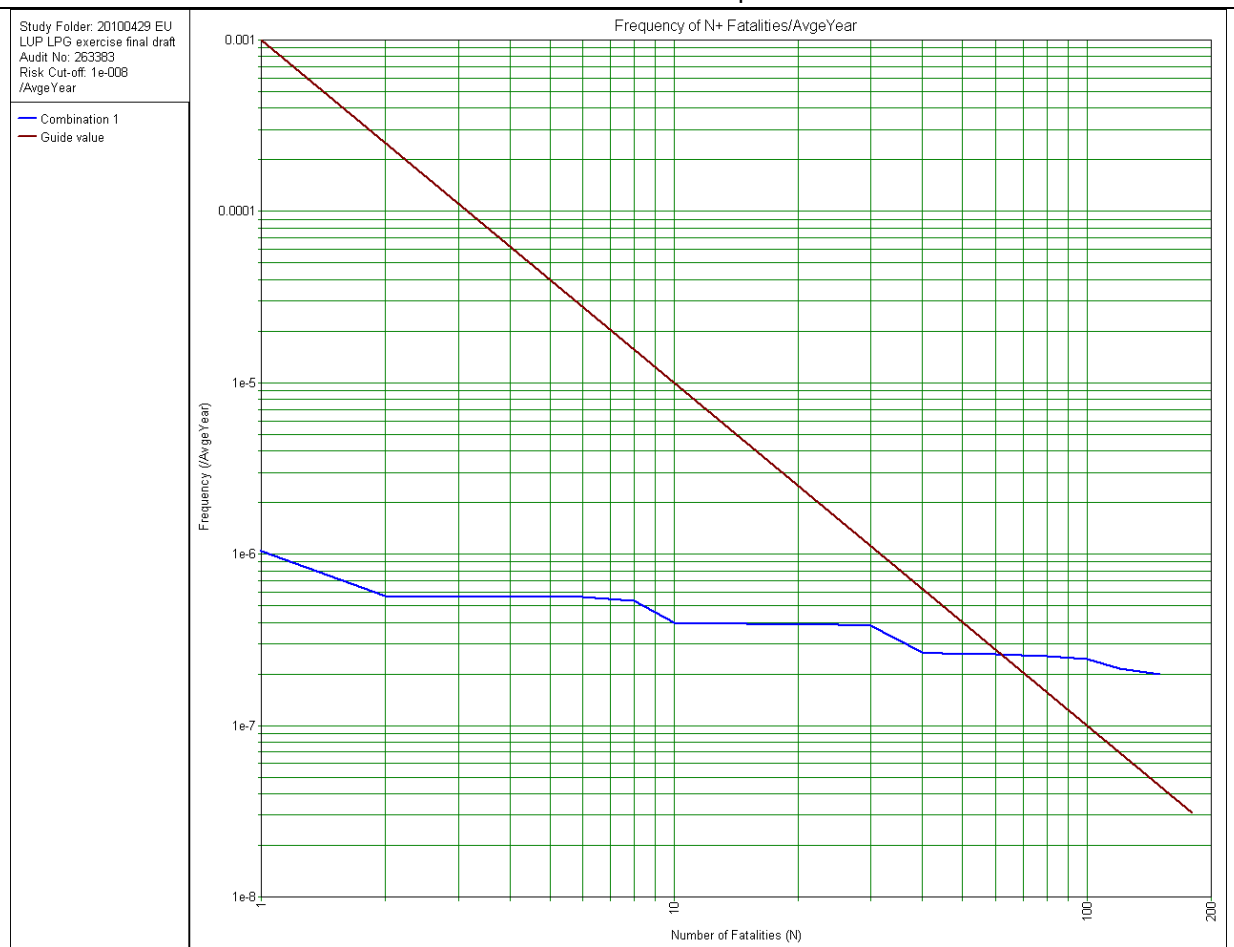

#### 47. Please add notes if you deem necessary to do so

The competent authority must account for the height of the societal risk. No actions are carried out for existing activities and land-use. For new activities or new land-use developments, additional safety measures (technical and organisational) and alternative locations for the chlorine plant, or alternative locations for the offices, school and houses must be seriously considered as the guidance values for societal risk are exceeded.

## Part VI: Mitigation of consequences

### Safety barriers

Provide information about safety barriers which you have considered for mitigating the consequence.

55. Describe the safety barrier(s) and the conditions of its(their) unavailability		
Safety barrier	Description	Conditions of unavailability
Remotely operated valve	Automatic detection but manual handling	probability of success 99% default duration of closure 600 s
Emergency shut-down valve (ESDV) and safety valve	Automatic detection and automatic handling	probability of success 99.9% default duration of closure 120 s

56. Please add notes if you deem necessary to do so

### 9.1 Part VII: Final Land Use Decision

In this section you should provide and justify your final decision regarding the location of the buildings as presented on the map. Also, for each of the building explain why these can or cannot be located in the current place and what you would do in case the building would not be allowed to be in that position.

57. Explain your final decisions regarding the location of the building.		
Location building	Final decision (Yes/No)	Explain your answer (in case of 'no' also explain what you would do with the building, e.g. remove house/factory, etc)
A (school)	Yes	Outside IR 10-6 contour
B (house)	Yes	Outside IR 10-6 contour
C (house)	Yes	Outside IR 10-6 contour
D (house)	Yes	Outside IR 10-6 contour
E (house)	Yes	Outside IR 10-6 contour
F (house)	Yes	Outside IR 10-6 contour
G (house)	Yes	Outside IR 10-6 contour

H (house)	Yes	Outside IR 10-6 contour
I (house)	Yes	Object I lies within the IR 10-6 contour. As the density of houses is less than 2 per ha in the current benchmark study, this house is regarded as an isolated house. Therefore, this is an object of limited vulnerability, not a vulnerable object. These objects are highly undesirable within the IR 10-6 contour, but not totally unacceptable. Efforts should be made to reduce risk or to buy-out the owners (if public funding is available)
J (office building)	No	This office lies within the IR 10-6 contour. As the number of persons is high, this objects is regarded as a vulnerable object and the presence within the 10-6 contour is unacceptable. Presuming the facility has a valid permit, the public authorities need to pay the buy-out or relocation of the office building. If this had been a request for a new permit or a change in the permit, the permit would not have been issued as the risk situation is unacceptable.
K (office building)	Yes	Outside 10-6 risk contour

## **Annex III Identification of possible causes and safety barriers**

In this section a list of possible causes of failure and safety barriers are demonstrated. The purpose of the two lists are to give some examples and therefore they are not exclusive. All lists can be extended with additional examples.

Example of possible causes relevant to the selected piece of equipment

Detailed identification of causes of potential failures are usually done by different types of hazard analysis procedures like HAZOP, HAZID etc. analysis. Human error is also a possible cause of all discussed pieces of equipment, therefore it is not specified below.

The selected types of equipment are as followings:

Storage tank – above ground

Pipework

Pump/compressor

Loading/unloading arm/hose

Road tanker/rail tanker

Carrier

### **1. Storage tank – above ground**

Storage tanks are considered either pressurised or atmospheric tanks. Possible causes of storage tanks failure could be mechanical causes, like:

design error,

material and/or construction defect,

mechanical malfunction,

material fatigue,

overfilling/overload,

corrosion,

embrittlement,

under or overpressure.

Other than the mechanical causes, also external impacts can cause failure of above ground storage tanks, like:

extreme weather,

natural disasters (flood, earthquakes, landslides etc.),

domino effect.

### **2. Pipework**

Possible causes of pipework failure could be mechanical causes, like:

material defect,

wrong installation,

corrosion,

erosion,

vibration,

embrittlement,

overpressure.

Other than the mechanical causes, also external impacts can cause failure of pipework, like:

extreme weather,  
natural disasters (flood, earthquakes, landslides etc.),  
domino effect.

### **3. Pump/compressor**

Possible causes of pump/compressor failure could be mechanical causes, like:

- material defect,
- overloading,
- external impact,
- corrosion,
- erosion,
- vibration,
- embrittlement,
- overpressure,
- more output than input caused underpressure,

Other than the mechanical causes, also external impacts can cause failure of pump/compressor, like:

- extreme weather,
- natural disasters (flood, earthquakes, landslides etc.),
- domino effect.

### **4. Loading/unloading arm/hose**

Possible causes of loading/unloading arm/hose failure could be mechanical causes, like:

design error,  
disconnect during load/unload,  
material and/or construction defect,  
mechanical malfunction,  
material fatigue,  
overfilling/overload,  
corrosion,  
embrittlement,  
under pressure.

Other than the mechanical causes, also external impacts can cause failure of loading/unloading arm/hose, like:

extreme weather,  
natural disasters (flood, earthquakes, landslides etc.),  
domino effect.

### **5. Road tanker/rail tanker and carrier**

Failure of road or rail tankers and carriers are similar to the failures of storage tanks. Possible causes of road tanker/rail tanker and carrier failure could be mechanical causes, like:

design error,  
material and/or construction defect,  
vibration,  
mechanical malfunction,

material fatigue,  
overfilling/overload,  
corrosion,  
embrittlement,  
under pressure.

Other than the mechanical causes, also external impacts can cause failure of road tanker/rail tanker and carrier, like:  
extreme weather,  
natural disasters (flood, earthquakes, landslides etc.),  
domino effect.

### **Example of identified safety barriers to the selected piece of equipment**

In this part non-exclusive lists of possible safety barriers are presented. These are examples for the selected types of equipment and there can be vary that are not on the lists below which could also be considered. (Source: Bologna report)

#### **1. Pressurised storage tank – above ground**

Pressure relief system  
Isolation (Emergency Shut Down) System  
Corrective actions on alarms for safety relevant parameters (level, pressure, temperature)  
Redundancy on level control/alarm  
Corrective actions on alarms for incident detection (flammable gas, fire and smoke)  
Firefighting system (water sprinklers, foam, dry chemical)  
Design and material for low temperature  
Design for vacuum  
Diversion wall and ground slope  
Protection against damage by vehicles (fence, crash barrier, etc.)  
Water draining

#### **2. Atmospheric storage tank – above ground**

Pressure relief valve  
Vacuum relief valve  
Inert gas paddling system  
Isolation (Emergency Shut Down) System  
Corrective actions on alarms for safety relevant parameters (level)  
Corrective actions on alarms for incident detection (flammable gas, fire and smoke)  
Firefighting system (water sprinklers, foam, dry chemical)  
Bund  
Water draining

#### **3. Pipework**

Pressure relief valve  
Isolation (Emergency Shut Down) System  
Corrective actions on alarms for incident detection (gas, flame detector)  
Firefighting system (foam, dry chemical)  
Thermal insulation  
Protection against vehicle impact  
Protection from external corrosion (paint, wrap, etc.)



#### **4. Pump/compressor**

Blocking valve

Non-returning valve

Shut-off valve

Excess flow valve

Bunds

Fire resisting coat

Fire protection (water curtain)

Gas/leak detection and stop flow

#### **5. Loading/unloading arm/hose; Road tanker/rail tanker and carrier**

Isolation (Emergency Shut Down) System

Interlock system on vehicle movement

Excess flow valve

Corrective actions on alarms for safety relevant parameters (level, transferred quantity)

Corrective actions on alarms for incident detection (gas, fire detector)

Fire protection (water sprinklers)

Ground slope and drainage

Design for full containment (provides some protection from pressure and vacuum)

Protection from static electricity

Protection against vehicle impact

Vessel, connection and equipment identification

## 10 References

- Ale B.J.M. (2002) "Risk assessment practices in the Netherlands", *Safety Science*, 40, 105-126.
- Basta C., Struckl M. and Christou M. (2008) "Implementing Art 12 of the Seveso II Directive: Overview of Roadmaps for Land-Use Planning in Selected Member States", European Commission Joint Research Centre - Institute for the Protection and Security of the Citizen, EUR 23519 EN, 2008.
- CEC – Commission of the European Communities: Directive "On the control of major-accident hazards involving dangerous substances" (96/82/EC). Official Journal of the European Communities No L 10, 14.1.1997, pp. 13-33.
- CEC – Commission of the European Communities: "Directive 105/96/EC Amending Directive 96/82/EC on the control of major-accident hazards involving dangerous substances". Official Journal of the European Communities No L 345, 31.12.2003, pp. 97-105.
- Christou M. and Porter S. (1999a) Guidance on Land Use Planning as required by Council Directive 96/82/EC (Seveso II), EUR 18695 EN.
- Christou M., Struckl M. and Biermann T. (2006) Land use Planning Guidelines in the Context of Article 12 of the Seveso II Directive 96/82/EC as Amended by Directive 105/2003/EC, European Commission Joint Research Centre - Institute for the Protection and Security of the Citizen, EUR 22634 EN FR DE.
- Cozzani V., Bandini R., Basta C., Christou M. (2006) Application of land-use planning criteria for the control of major accident hazards: A case-study, *J. of Hazardous Materials A136* (2006) pp. 170–180.
- Delvosalle C., Fievez C., Pipart A., Casal Fabrega J., Planas E., Christou M., Mushtaq F., (2005) Identification of reference accident scenarios in SEVESO establishments, *Reliability Engineering and System Safety*, 90 (2005), pp. 238–246.
- Delvosalle C, Fievez C, Pipart A, Debray B. (2006) ARAMIS project: A comprehensive methodology for the identification of reference accident scenarios in process industries. *J. of Hazardous Materials* 130: 200–219 (2006)
- Gyenes, Z. (2009) "Scenario Trees for Land-Use Planning", Material as agreed at the meeting of the Land-Use Planning Subgroup for Objective 2, Valletta, Malta 23-24th September 2009.
- Gyenes et.al. (2010) "Selecting accident scenarios for land use planning purposes", in *Reliability, Risk and Safety – Ale, Papazoglou & Zio* (eds,) 2010 Taylor & Francis Group, London, ISBN 978-0-415-60427-7, pp.557-565.
- Flemish Government (2009) "Handbook Failure Frequencies" [http://www.lne.be/themas/veiligheidsrapportage/rlbvr/bestanden-rlbvr/tr/vr\\_rlbvr\\_rl\\_hbff\\_EN.pdf](http://www.lne.be/themas/veiligheidsrapportage/rlbvr/bestanden-rlbvr/tr/vr_rlbvr_rl_hbff_EN.pdf)

***Europe Direct is a service to help you find answers  
to your questions about the European Union.***

**Freephone number (\*):**

**00 800 6 7 8 9 10 11**

(\* ) The information given is free, as are most calls (though some operators, phone boxes or hotels may charge you).

More information on the European Union is available on the internet (<http://europa.eu>).

## **HOW TO OBTAIN EU PUBLICATIONS**

### **Free publications:**

- one copy:  
via EU Bookshop (<http://bookshop.europa.eu>);
- more than one copy or posters/maps:  
from the European Union's representations ([http://ec.europa.eu/represent\\_en.htm](http://ec.europa.eu/represent_en.htm));  
from the delegations in non-EU countries ([http://eeas.europa.eu/delegations/index\\_en.htm](http://eeas.europa.eu/delegations/index_en.htm));  
by contacting the Europe Direct service ([http://europa.eu/eurodirect/index\\_en.htm](http://europa.eu/eurodirect/index_en.htm)) or  
calling 00 800 6 7 8 9 10 11 (freephone number from anywhere in the EU) (\*).

(\* ) The information given is free, as are most calls (though some operators, phone boxes or hotels may charge you).

### **Priced publications:**

- via EU Bookshop (<http://bookshop.europa.eu>).

## JRC Mission

As the science and knowledge service of the European Commission, the Joint Research Centre's mission is to support EU policies with independent evidence throughout the whole policy cycle.



**EU Science Hub**  
[ec.europa.eu/jrc](https://ec.europa.eu/jrc)



@EU\_ScienceHub



EU Science Hub - Joint Research Centre



Joint Research Centre



EU Science Hub



Publications Office

doi: 10.2760/884152

ISBN 978-92-79-66670-4